











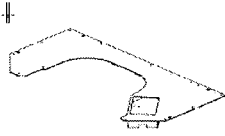
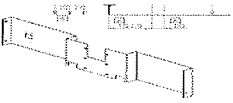



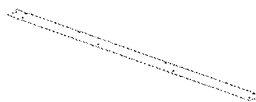

序号	内部号	型式	简图	数量	颜色	检查内容	工序	
1	8	5144886		11	白皱	①确认颜色正确 ②确认无毛刺	<input checked="" type="checkbox"/> <input checked="" type="checkbox"/>	
2	8	5388001		2	白皱	确认颜色正确 确认无毛刺 确认无变形 过丝确认	<input checked="" type="checkbox"/> <input checked="" type="checkbox"/> <input checked="" type="checkbox"/> <input checked="" type="checkbox"/>	ALW
3	8	5387938		2	白皱	①确认颜色正确 ②确认无毛刺	<input type="checkbox"/> <input checked="" type="checkbox"/>	ALW
4	8	5387935		2	白皱	确认颜色正确 确认无毛刺 确认无变形 过丝确认	<input checked="" type="checkbox"/> <input checked="" type="checkbox"/> <input checked="" type="checkbox"/> <input type="checkbox"/>	ALW
5	8	5387929		2	白平	确认颜色正确 确认无毛刺 确认无变形 过丝确认	<input checked="" type="checkbox"/> <input checked="" type="checkbox"/> <input checked="" type="checkbox"/> <input checked="" type="checkbox"/>	ALW
6	8	5388056		2	白平	确认颜色正确 确认无毛刺 确认无变形 过丝确认	<input checked="" type="checkbox"/> <input checked="" type="checkbox"/> <input checked="" type="checkbox"/> <input checked="" type="checkbox"/>	ALW
7	8	5388058		2	白平	确认颜色正确 确认无毛刺 确认无变形 过丝确认	<input checked="" type="checkbox"/> <input checked="" type="checkbox"/> <input checked="" type="checkbox"/> <input checked="" type="checkbox"/>	ALW
8	8	5387992		2	白皱	确认颜色正确 确认无毛刺 确认无变形 过丝确认	<input checked="" type="checkbox"/> <input checked="" type="checkbox"/> <input checked="" type="checkbox"/> <input checked="" type="checkbox"/>	ALW
9	8	5387993		2	白皱	①确认颜色正确 ②确认无毛刺	<input checked="" type="checkbox"/> <input checked="" type="checkbox"/>	ALW
10	8	5387994		2	白皱	确认颜色正确 确认无毛刺 确认无变形 过丝确认	<input checked="" type="checkbox"/> <input checked="" type="checkbox"/> <input checked="" type="checkbox"/> <input checked="" type="checkbox"/>	ALW

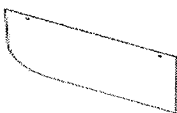
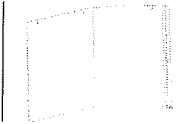
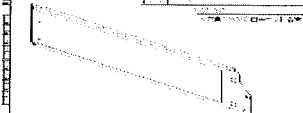
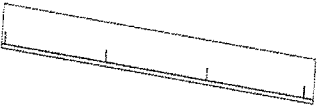
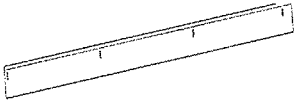
11	8	5387995		2	白皱	①确认颜色正确 ②确认无毛刺	<input checked="" type="checkbox"/> <input checked="" type="checkbox"/>	ALW
12	8	5387989		2	白皱	确认颜色正确 确认无毛刺 确认无变形 过丝确认	<input checked="" type="checkbox"/> <input checked="" type="checkbox"/> <input checked="" type="checkbox"/> <input checked="" type="checkbox"/>	ALW
13	8	5388041		2	白皱	①确认颜色正确 ②确认无毛刺	<input checked="" type="checkbox"/> <input checked="" type="checkbox"/>	ALW
14	8	5388032		2	黑皱	确认颜色正确 确认无毛刺 确认无变形 过丝确认	<input checked="" type="checkbox"/> <input checked="" type="checkbox"/> <input checked="" type="checkbox"/> <input checked="" type="checkbox"/>	ALW
15	8	5388034		2	黑皱	①确认颜色正确 ②确认无毛刺	<input checked="" type="checkbox"/> <input checked="" type="checkbox"/>	ALW
16	8	5388037		2	黑皱	①确认颜色正确 ②确认无毛刺	<input checked="" type="checkbox"/> <input checked="" type="checkbox"/>	ALW
17	8	5387936		2	白皱	①确认颜色正确 ②确认无毛刺	<input checked="" type="checkbox"/> <input checked="" type="checkbox"/>	ALW
18	8	5387937		2	白皱	确认颜色正确 确认无毛刺 确认无变形 过丝确认	<input checked="" type="checkbox"/> <input checked="" type="checkbox"/> <input checked="" type="checkbox"/> <input checked="" type="checkbox"/>	ALW
19	8	5388049		2	白平	①确认颜色正确 ②确认无毛刺	<input checked="" type="checkbox"/> <input checked="" type="checkbox"/>	ALW
20	8	5388051		2	白平	①确认颜色正确 ②确认无毛刺	<input checked="" type="checkbox"/> <input checked="" type="checkbox"/>	ALW
21	8	5388054		2	白平	①确认颜色正确 ②确认无毛刺	<input checked="" type="checkbox"/> <input checked="" type="checkbox"/>	ALW

22	8	5549914		1	白皱	①确认颜色正确 ②确认无毛刺	<input checked="" type="checkbox"/> <input checked="" type="checkbox"/>	LCA
23	8	5549913		4	白皱	确认颜色正确 确认无毛刺 确认无变形 过丝确认	<input checked="" type="checkbox"/> <input checked="" type="checkbox"/> <input checked="" type="checkbox"/> <input checked="" type="checkbox"/>	LCA