

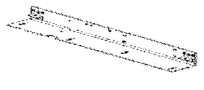

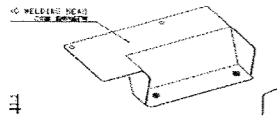

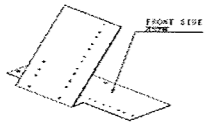







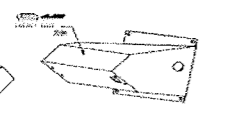
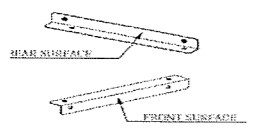
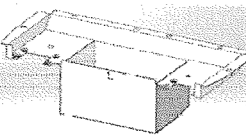
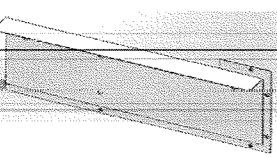
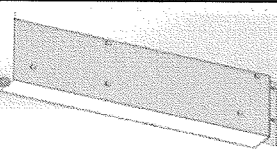
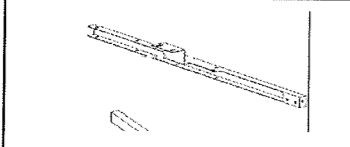
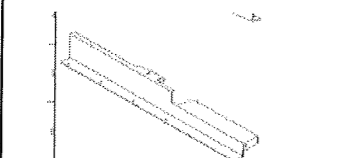
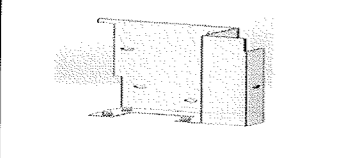
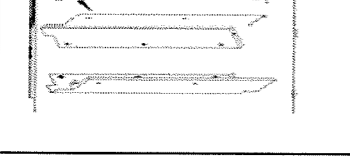
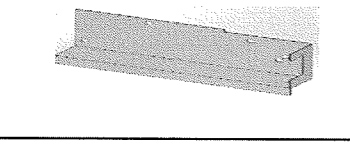
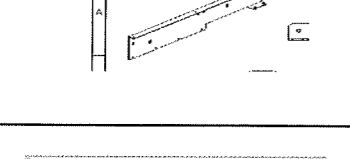
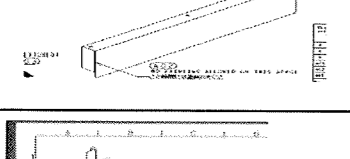
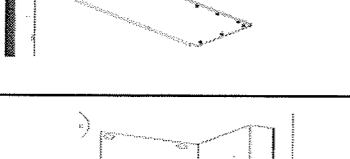
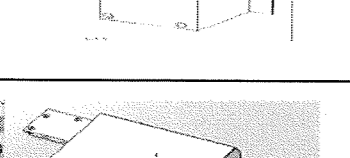
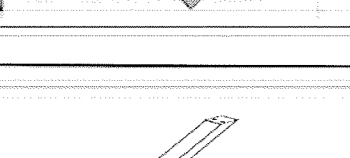
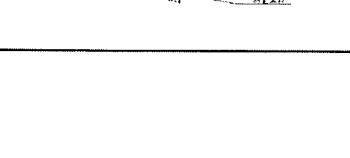
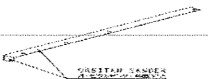
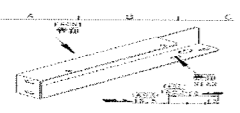
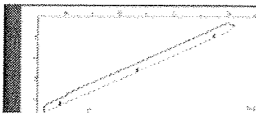

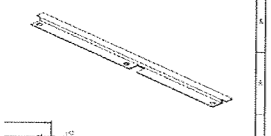

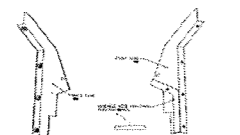
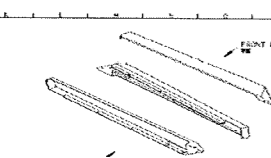
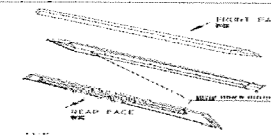
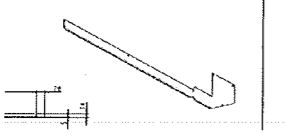
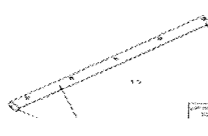
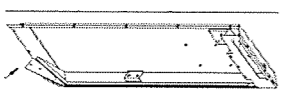
600-0508/0509 (2套)

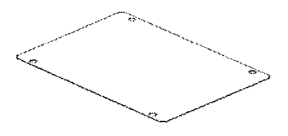
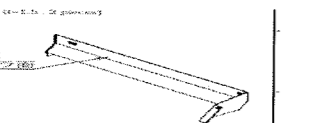
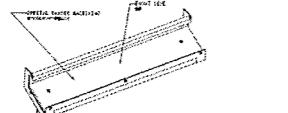
序号	物料号	内部号	简图	数量	颜色	备注	检查
1	B6802791A02	1		1	黑平/黑色 /9005HS50	确认颜色正确 确认无毛刺 确认无变形 过丝确认	<input checked="" type="checkbox"/> <input checked="" type="checkbox"/> <input checked="" type="checkbox"/> <input checked="" type="checkbox"/>
2	H0704293B01	1		1	白皱/カルサイ トホワイト (凹凸) /9NT06835HL	确认颜色正确 确认无毛刺 确认无变形 过丝确认	<input checked="" type="checkbox"/> <input checked="" type="checkbox"/> <input checked="" type="checkbox"/> <input checked="" type="checkbox"/>
3	H3201597B01	1		1	白皱/カルサイ トホワイト (凹凸) /9NT06835HL	确认颜色正确 确认无毛刺 确认无变形 过丝确认	<input checked="" type="checkbox"/> <input checked="" type="checkbox"/> <input checked="" type="checkbox"/> <input checked="" type="checkbox"/>
4	H3201662B01	1		2	黑平/黑 /9005HS50	①确认颜色正确 ②确认无毛刺	<input checked="" type="checkbox"/> <input checked="" type="checkbox"/>
5	H3201665A02	1		1	发丝	①确认颜色正确 ②确认无毛刺	<input checked="" type="checkbox"/> <input checked="" type="checkbox"/>
6	H3201670B01	1		2	黑平/黑色 /9005HS50	①确认颜色正确 ②确认无毛刺	<input checked="" type="checkbox"/> <input checked="" type="checkbox"/>
7	H8104543A02	1		1	白皱/カルサイ トホワイト /9NT06835HL	确认颜色正确 确认无毛刺 确认无变形 过丝确认	<input checked="" type="checkbox"/> <input checked="" type="checkbox"/> <input checked="" type="checkbox"/> <input checked="" type="checkbox"/>
8	H8105043A02	1		1	白皱/カルサイ トホワイト (凹凸) /9NT06835HL	确认颜色正确 确认无毛刺 确认无变形 过丝确认	<input checked="" type="checkbox"/> <input checked="" type="checkbox"/> <input checked="" type="checkbox"/> <input checked="" type="checkbox"/>
9	H8105065A01	1		1	发丝	确认颜色正确 确认无毛刺 确认无变形 过丝确认	<input checked="" type="checkbox"/> <input checked="" type="checkbox"/> <input checked="" type="checkbox"/> <input checked="" type="checkbox"/>
10	H8105066A01	1		1	发丝	①确认颜色正确 ②确认无毛刺	<input checked="" type="checkbox"/> <input checked="" type="checkbox"/>
11	H8105067A01	1		1	发丝	①确认颜色正确 ②确认无毛刺	<input checked="" type="checkbox"/> <input checked="" type="checkbox"/>

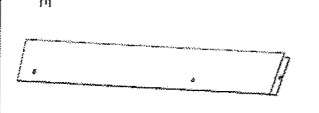
12	H8105068A02	1		1	白皱/カルサイト トホワイト (凹凸) /9NT06835HL	确认颜色正确 确认无毛刺 确认无变形 过丝确认	<input checked="" type="checkbox"/> <input checked="" type="checkbox"/> <input checked="" type="checkbox"/> <input checked="" type="checkbox"/>
13	H8105069A03	1		1	白皱/カルサイ トホワイト (凹凸) /9NT06835HL	确认颜色正确 确认无毛刺 确认无变形 过丝确认	<input checked="" type="checkbox"/> <input checked="" type="checkbox"/> <input checked="" type="checkbox"/> <input checked="" type="checkbox"/>
14	H8105070A01	1		1	发丝	①确认颜色正确 ②确认无毛刺	<input checked="" type="checkbox"/> <input checked="" type="checkbox"/>
15	H8105071B02	1		1	白皱/カルサイ トホワイト (凹凸) /9NT06835HL	①确认颜色正确 ②确认无毛刺	<input checked="" type="checkbox"/> <input checked="" type="checkbox"/>
16	H8105073A01	1		1	发丝	①确认颜色正确 ②确认无毛刺	<input checked="" type="checkbox"/> <input checked="" type="checkbox"/>
17	H8105077B01	1		1	黑平/黑涂装 /9005HS50	确认颜色正确 确认无毛刺 确认无变形 过丝确认	<input checked="" type="checkbox"/> <input checked="" type="checkbox"/> <input checked="" type="checkbox"/> <input checked="" type="checkbox"/>
18	H8105078A03	1		1	白皱/カルサイ トホワイト (凹凸) /9NT06835HL	①确认颜色正确 ②确认无毛刺	<input checked="" type="checkbox"/> <input checked="" type="checkbox"/>
19	H8105079A03	1		1	黑皱/グラフ イトブラック (凹凸) /0NT00281HL	确认颜色正确 确认无毛刺 确认无变形 过丝确认	<input checked="" type="checkbox"/> <input checked="" type="checkbox"/> <input checked="" type="checkbox"/> <input checked="" type="checkbox"/>
20	H8105094A01	1		1	黑皱/グラフ イトブラック (凹凸) /0NT00281HL	①确认颜色正确 ②确认无毛刺	<input checked="" type="checkbox"/> <input checked="" type="checkbox"/>
21	H8105097A01	1		1	发丝	①确认颜色正确 ②确认无毛刺	<input checked="" type="checkbox"/> <input checked="" type="checkbox"/>
22	H8105101A02	1		1	黑平/黑涂装 /9005HS50	①确认颜色正确 ②确认无毛刺	<input checked="" type="checkbox"/> <input checked="" type="checkbox"/>

23	H8105117A01	1		1	白钢	①确认颜色正确 ②确认无毛刺	<input checked="" type="checkbox"/> <input checked="" type="checkbox"/>
24	H8105118A03	1		1	黑平/黑色 /9005HS50	①确认颜色正确 ②确认无毛刺	<input checked="" type="checkbox"/> <input checked="" type="checkbox"/>
25	H8105119A03	1		1	白皱/カルサイト トホワイト /9NT06835HL	①确认颜色正确 ②确认无毛刺	<input checked="" type="checkbox"/> <input checked="" type="checkbox"/>
26	H8105121A01	1		1	白钢	①确认颜色正确 ②确认无毛刺	<input checked="" type="checkbox"/> <input checked="" type="checkbox"/>
27	H8105132A01	1		1	白皱/カルサイト トホワイト /9NT06835HL	①确认颜色正确 ②确认无毛刺	<input checked="" type="checkbox"/> <input checked="" type="checkbox"/>
28	H8105372A02	1		1	白皱/カルサイト トホワイト (凹凸) /9NT06835HL	确认颜色正确 确认无毛刺 确认无变形 过丝确认	<input checked="" type="checkbox"/> <input checked="" type="checkbox"/> <input checked="" type="checkbox"/> <input checked="" type="checkbox"/>
29	H8105575A01	1		1	白皱/カルサイト トホワイト (凹凸) /9NT06835HL	确认颜色正确 确认无毛刺 确认无变形 过丝确认	<input checked="" type="checkbox"/> <input checked="" type="checkbox"/> <input checked="" type="checkbox"/> <input checked="" type="checkbox"/>
30	H8106188A01	1		1	白皱/カルサイト トホワイト (凹凸) /9NT06835HL	确认颜色正确 确认无毛刺 确认无变形 过丝确认	<input checked="" type="checkbox"/> <input checked="" type="checkbox"/> <input checked="" type="checkbox"/> <input checked="" type="checkbox"/>
31	H8106189A01	1		1	白皱/カルサイト トホワイト (凹凸) /9NT06835HL	确认颜色正确 确认无毛刺 确认无变形 过丝确认	<input checked="" type="checkbox"/> <input checked="" type="checkbox"/> <input checked="" type="checkbox"/> <input checked="" type="checkbox"/>
32	H8106193A01	1		1	白皱/カルサイト トホワイト (凹凸) /9NT06835HL	①确认颜色正确 ②确认无毛刺	<input checked="" type="checkbox"/> <input checked="" type="checkbox"/>
33	SBF3034227A	1		1	表面抛光处理	①确认颜色正确 ②确认无毛刺	<input checked="" type="checkbox"/> <input checked="" type="checkbox"/>

34	H0003453B03	1		1	白皱/カルサイト トホワイト /9NT06835HL	确认颜色正确 确认无毛刺 确认无变形 过丝确认	<input checked="" type="checkbox"/> <input checked="" type="checkbox"/> <input checked="" type="checkbox"/> <input checked="" type="checkbox"/>
35	H0003459B01	1		1	白皱/カルサイ トホワイト /9NT06835HL	①确认颜色正确 ②确认无毛刺	<input checked="" type="checkbox"/> <input checked="" type="checkbox"/>
36	H0504965A01	1		1	巴扑		<i>OK</i>
37	H3201672B01	1		1	白皱/カルサイ トホワイト (凹凸) /9NT06835HL	①确认颜色正确 ②确认无毛刺	<input checked="" type="checkbox"/> <input checked="" type="checkbox"/>
38	H8105161A01	1		1	白皱/カルサイ トホワイト /9NT06835HL	确认颜色正确 确认无毛刺 确认无变形 过丝确认	<input checked="" type="checkbox"/> <input checked="" type="checkbox"/> <input checked="" type="checkbox"/> <input checked="" type="checkbox"/>
39	H8105183C01	1		1	扒扑	确认颜色正确 确认无毛刺 确认无变形 过丝确认	<input checked="" type="checkbox"/> <input checked="" type="checkbox"/> <input checked="" type="checkbox"/> <input checked="" type="checkbox"/>
40	H8105265A01	1		1	巴扑	①确认颜色正确 ②确认无变形 ③确认挂钩处理 ④过丝 ⑤确认标识, 明细准确附带 ⑥确认无漏发	<input checked="" type="checkbox"/> <input checked="" type="checkbox"/> <input checked="" type="checkbox"/> <input checked="" type="checkbox"/> <input checked="" type="checkbox"/> <input checked="" type="checkbox"/>
41	H8106217A01	1		1	黑皱/グラフ イトブラック (凹凸) /0NT00281HL	确认颜色正确 确认无毛刺 确认无变形 过丝确认	<input checked="" type="checkbox"/> <input checked="" type="checkbox"/> <input checked="" type="checkbox"/> <input checked="" type="checkbox"/>
42	H8106471A01	1		1	白皱/カルサイ トホワイト (凹凸) /9NT06835HL	①确认颜色正确 ②确认无毛刺	<input checked="" type="checkbox"/> <input checked="" type="checkbox"/>
43	H8106472A01	1		1	白皱/カルサイ トホワイト (凹凸) /9NT06835HL	①确认颜色正确 ②确认无毛刺	<input checked="" type="checkbox"/> <input checked="" type="checkbox"/>
44	H8105853A01	1		1	白皱/カルサイ トホワイト /9NT06835HL	确认颜色正确 确认无毛刺 确认无变形 过丝确认	<input checked="" type="checkbox"/> <input checked="" type="checkbox"/> <input checked="" type="checkbox"/> <input checked="" type="checkbox"/>

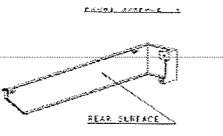
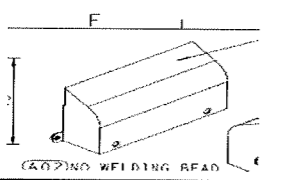
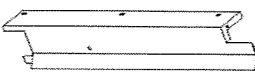
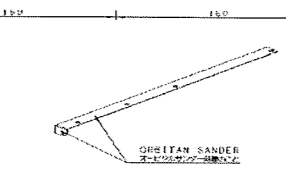
45	H8105918A01	1		1	黑皱/グラフィ イトブラック (凹凸) /ONT00281HL	确认颜色正确 确认无毛刺 确认无变形 过丝确认	<input checked="" type="checkbox"/> <input checked="" type="checkbox"/> <input checked="" type="checkbox"/> <input checked="" type="checkbox"/>	
46	H8105919A02	1		1	白皱/カルサイ トホワイト (凹凸) /9NT06835HL	确认颜色正确 确认无毛刺 确认无变形 过丝确认	<input checked="" type="checkbox"/> <input checked="" type="checkbox"/> <input checked="" type="checkbox"/> <input checked="" type="checkbox"/>	
47	5246402	1		1	白皱/カルサイ トホワイト (凹凸) /9NT06835HL	①确认颜色正确 ②确认无毛刺	<input checked="" type="checkbox"/> <input checked="" type="checkbox"/>	
48	5295881	1		1	抹油	①确认颜色正确 ②确认无毛刺	<input checked="" type="checkbox"/> <input checked="" type="checkbox"/>	刘春哥