

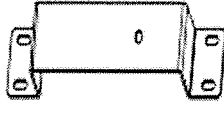









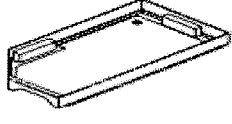
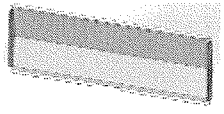
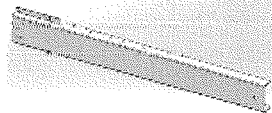

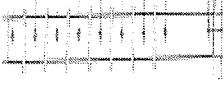
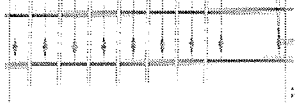

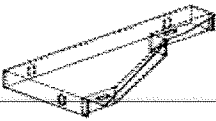
CPP63241101第十四批

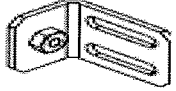
| 序号 | 物料号 | 内部号 | 简图 | 数量 | 颜色 | 检查内容 | 备注 |
|----|---------|-----|---|----|----|----------------------------------|---|
| 1 | 5144751 | 5 |  | 1 | 白平 | 确认颜色正确 确认无毛刺 确认无变形 过丝确认 | <input checked="" type="checkbox"/> <input checked="" type="checkbox"/> <input checked="" type="checkbox"/> <input checked="" type="checkbox"/> ALW |
| 2 | 5144752 | 5 |  | 1 | 白平 | 确认颜色正确 确认无毛刺 确认无变形 过丝确认 | <input checked="" type="checkbox"/> <input checked="" type="checkbox"/> <input checked="" type="checkbox"/> <input checked="" type="checkbox"/> ALW |
| 3 | 5145109 | 5 |  | 1 | 白皱 | ①确认颜色正确 ②确认无毛刺 | <input checked="" type="checkbox"/> ALW |
| 4 | 5145110 | 5 |  | 1 | 白皱 | 确认颜色正确 确认无毛刺 确认无变形 过丝确认 | <input checked="" type="checkbox"/> <input checked="" type="checkbox"/> <input checked="" type="checkbox"/> <input checked="" type="checkbox"/> ALW |
| 5 | 5168422 | 5 |  | 1 | 白平 | ①确认颜色正确 ②确认无毛刺 | <input checked="" type="checkbox"/> <input checked="" type="checkbox"/> ALW |
| 6 | 5168431 | 5 |  | 1 | 白皱 | ①确认颜色正确 ②确认无毛刺 | <input checked="" type="checkbox"/> <input checked="" type="checkbox"/> ALW |
| 7 | 5168438 | 5 |  | 1 | 白皱 | ①确认颜色正确 ②确认无毛刺 | <input checked="" type="checkbox"/> <input checked="" type="checkbox"/> ALW |
| 8 | 5168447 | 5 |  | 1 | 白平 | ①确认颜色正确 ②确认无毛刺 | <input checked="" type="checkbox"/> <input checked="" type="checkbox"/> ALW |
| 9 | 5168982 | 5 |  | 2 | 白平 | ①确认颜色正确 ②确认无毛刺 | <input checked="" type="checkbox"/> <input checked="" type="checkbox"/> ALW |
| 10 | 5168984 | 5 |  | 2 | 白平 | ①确认颜色正确 ②确认无毛刺 | <input checked="" type="checkbox"/> <input checked="" type="checkbox"/> ALW |

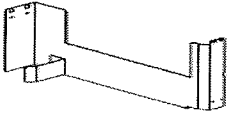
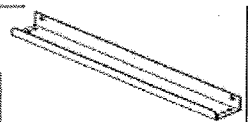
| | | | | | | | | |
|----|---------|---|---|---|----|----------------------------------|--|-----|
| 11 | 5168986 | 5 |  | 1 | 白平 | ①确认颜色正确 ②确认无毛刺 | <input checked="" type="checkbox"/> <input checked="" type="checkbox"/> | ALW |
| 12 | 5189795 | 5 |  | 1 | 白平 | ①确认颜色正确 ②确认无毛刺 | <input checked="" type="checkbox"/> <input checked="" type="checkbox"/> | ALW |
| 13 | 5189801 | 5 |  | 1 | 白平 | 确认颜色正确 确认无毛刺 确认无变形 过丝确认 | <input checked="" type="checkbox"/> <input checked="" type="checkbox"/> <input checked="" type="checkbox"/> <input checked="" type="checkbox"/> | ALW |
| 14 | 5189945 | 5 |  | 1 | 白平 | 确认颜色正确 确认无毛刺 确认无变形 过丝确认 | <input checked="" type="checkbox"/> <input checked="" type="checkbox"/> <input checked="" type="checkbox"/> <input checked="" type="checkbox"/> | ALW |
| 15 | 5189946 | 5 |  | 1 | 白平 | 确认颜色正确 确认无毛刺 确认无变形 过丝确认 | <input checked="" type="checkbox"/> <input checked="" type="checkbox"/> <input checked="" type="checkbox"/> <input checked="" type="checkbox"/> | ALW |
| 16 | 5190562 | 5 |  | 2 | 白平 | 确认颜色正确 确认无毛刺 确认无变形 过丝确认 | <input checked="" type="checkbox"/> <input checked="" type="checkbox"/> <input checked="" type="checkbox"/> <input checked="" type="checkbox"/> | ALW |
| 17 | 5197762 | 5 |  | 1 | 白皱 | ①确认颜色正确 ②确认无毛刺 | <input checked="" type="checkbox"/> <input checked="" type="checkbox"/> | ALW |
| 18 | 5225245 | 5 |  | 1 | 白皱 | 确认颜色正确 确认无毛刺 确认无变形 过丝确认 | <input checked="" type="checkbox"/> <input checked="" type="checkbox"/> <input checked="" type="checkbox"/> <input checked="" type="checkbox"/> | ALW |
| 19 | 5224706 | 5 |  | 1 | 白平 | 确认颜色正确 确认无毛刺 确认无变形 过丝确认 | <input checked="" type="checkbox"/> <input checked="" type="checkbox"/> <input checked="" type="checkbox"/> <input checked="" type="checkbox"/> | ALW |
| 20 | 5225306 | 5 |  | 1 | 白皱 | 确认颜色正确 确认无毛刺 确认无变形 过丝确认 | <input checked="" type="checkbox"/> <input checked="" type="checkbox"/> <input checked="" type="checkbox"/> <input checked="" type="checkbox"/> | ALW |
| 21 | 5238001 | 5 |  | 2 | 白皱 | 确认颜色正确 确认无毛刺 确认无变形 过丝确认 | <input checked="" type="checkbox"/> <input checked="" type="checkbox"/> <input checked="" type="checkbox"/> <input checked="" type="checkbox"/> | ALW |

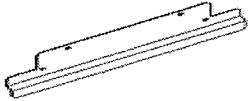
| | | | | | | | | |
|----|---------|---|---|---|----|-------------------|--|-----|
| 22 | 5223199 | 5 |  | 1 | 白皱 | ①确认颜色正确 ②确认无毛刺 | <input checked="" type="checkbox"/> <input checked="" type="checkbox"/> | ALW |
| 23 | 5223191 | 5 |  | 4 | 白平 | ①确认颜色正确 ②确认无毛刺 | <input checked="" type="checkbox"/> <input checked="" type="checkbox"/> | ALW |
| 24 | 5358375 | 5 |  | 1 | 白皱 | ①确认颜色正确 ②确认无毛刺 | <input checked="" type="checkbox"/> <input checked="" type="checkbox"/> | ALW |