

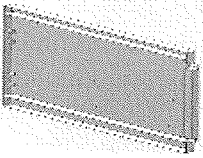
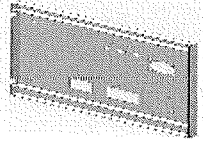
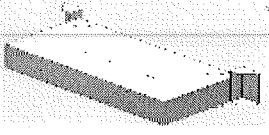
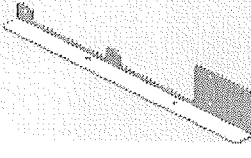
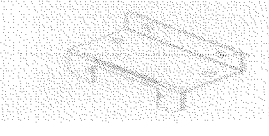
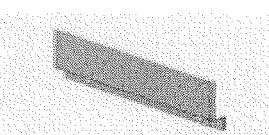
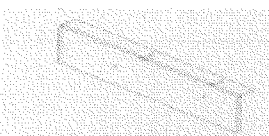
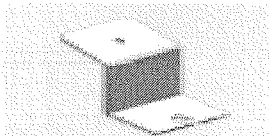
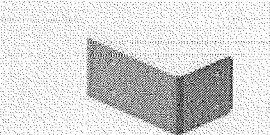
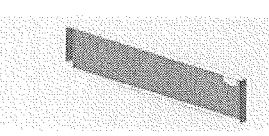
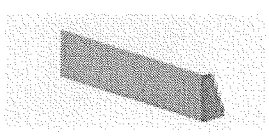
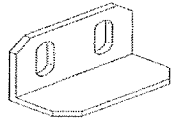
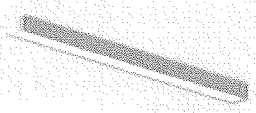
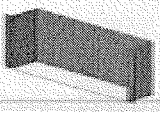
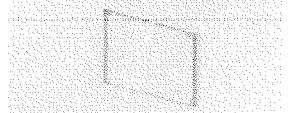
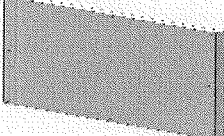
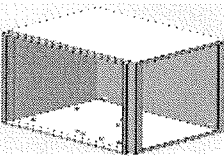
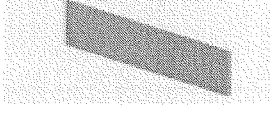
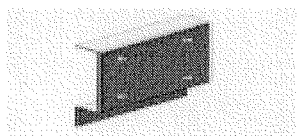
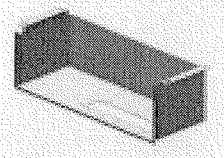
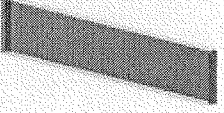
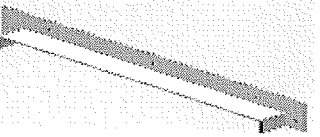
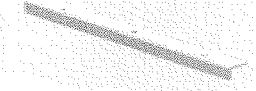
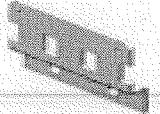

5500004-CPP63241101电柜9.11 (第38批)

序号	物料号	内部号	简图	数量	颜色	检查内容	备注
1	DC-37817A1	3797		1	户内白皱	确认颜色正确 确认无毛刺 确认无变形 过丝确认	<input checked="" type="checkbox"/> <input checked="" type="checkbox"/> <input checked="" type="checkbox"/> <input checked="" type="checkbox"/>
2	DC-37818A4	3798		1	户内白皱	确认颜色正确 确认无毛刺 确认无变形 过丝确认	<input checked="" type="checkbox"/> <input checked="" type="checkbox"/> <input checked="" type="checkbox"/> <input checked="" type="checkbox"/>
3	DC-37822 (DC-37819A2/DC-37820A1/)	3799		1	户内白皱	确认颜色正确 确认无毛刺 确认无变形 过丝确认	<input checked="" type="checkbox"/> <input checked="" type="checkbox"/> <input checked="" type="checkbox"/> <input checked="" type="checkbox"/>
4	DC-425200	3775		1	光泽镀锌	确认颜色正确 确认无毛刺 确认无变形 过丝确认	<input checked="" type="checkbox"/> <input checked="" type="checkbox"/> <input checked="" type="checkbox"/> <input checked="" type="checkbox"/>
5	DC-425201	3776		1	光泽镀锌	确认颜色正确 确认无毛刺 确认无变形 过丝确认	<input checked="" type="checkbox"/> <input checked="" type="checkbox"/> <input checked="" type="checkbox"/> <input checked="" type="checkbox"/>
6	DC-425202A3	3777		1	光泽镀锌	确认颜色正确 确认无毛刺 确认无变形 过丝确认	<input checked="" type="checkbox"/> <input checked="" type="checkbox"/> <input checked="" type="checkbox"/> <input checked="" type="checkbox"/>
7	DC-425203	3778		1	光泽镀锌	确认颜色正确 确认无毛刺 确认无变形 过丝确认	<input checked="" type="checkbox"/> <input checked="" type="checkbox"/> <input checked="" type="checkbox"/> <input checked="" type="checkbox"/>
8	DC-425204A1	3779		5	光泽镀锌	①确认颜色正确 ②确认无毛刺	<input checked="" type="checkbox"/> <input checked="" type="checkbox"/>
9	DC-425206	3780		1	光泽镀锌	①确认颜色正确 ②确认无毛刺	<input checked="" type="checkbox"/> <input checked="" type="checkbox"/>
10	DC-37815C2	4607		1	光泽镀锌	①确认颜色正确 ②确认无毛刺	<input checked="" type="checkbox"/> <input checked="" type="checkbox"/>
11	DC-37816B0	3782		1	光泽镀锌	①确认颜色正确 ②确认无毛刺	<input checked="" type="checkbox"/> <input checked="" type="checkbox"/>

12	DA-46212A0	3783		2	光泽镀锌	①确认颜色正确 ②确认无毛刺	<input checked="" type="checkbox"/> <input checked="" type="checkbox"/>
13	DC-425208A1	3784		2	光泽镀锌	①确认颜色正确 ②确认无毛刺	<input checked="" type="checkbox"/> <input checked="" type="checkbox"/>
14	DC-37813A1	3785		2	光泽镀锌	①确认颜色正确 ②确认无毛刺	<input checked="" type="checkbox"/> <input checked="" type="checkbox"/>
15	DC-425210A2	3786		1	光泽镀锌	①确认颜色正确 ②确认无毛刺	<input checked="" type="checkbox"/> <input checked="" type="checkbox"/>
16	DC-425211A1	3787		1	户内白皱	①确认颜色正确 ②确认无毛刺	<input checked="" type="checkbox"/> <input checked="" type="checkbox"/>
17	DC-37823A1	3788		1	户内白皱	确认颜色正确 确认无毛刺 确认无变形 过丝确认	<input checked="" type="checkbox"/> <input checked="" type="checkbox"/> <input checked="" type="checkbox"/> <input checked="" type="checkbox"/>
18	DC-425198A1	3789		1	光泽镀锌	①确认颜色正确 ②确认无毛刺	<input checked="" type="checkbox"/> <input checked="" type="checkbox"/>
19	DC-425199A1	3790		1	光泽镀锌	①确认颜色正确 ②确认无毛刺	<input checked="" type="checkbox"/> <input checked="" type="checkbox"/>
20	DC38017	3791		1	户内白皱	确认颜色正确 确认无毛刺 确认无变形 过丝确认	<input checked="" type="checkbox"/> <input checked="" type="checkbox"/> <input checked="" type="checkbox"/> <input checked="" type="checkbox"/>
21	DC38018	3792		1	户内白皱	①确认颜色正确 ②确认无毛刺	<input checked="" type="checkbox"/> <input checked="" type="checkbox"/>
22	DC38019	3793		1	光泽镀锌	①确认颜色正确 ②确认无毛刺	<input checked="" type="checkbox"/> <input checked="" type="checkbox"/>

23	DC38020	3794		1	光泽镀锌	①确认颜色正确 ②确认无毛刺	<input checked="" type="checkbox"/>
24	DC-37814	3795		1	光泽镀锌	确认颜色正确 确认无毛刺 确认无变形 过丝确认	<input checked="" type="checkbox"/> <input checked="" type="checkbox"/> <input checked="" type="checkbox"/> <input checked="" type="checkbox"/>
25	MPP-Q28-7514-0400	3796		1	光泽镀锌	确认颜色正确 确认无毛刺 确认无变形 过丝确认	<input checked="" type="checkbox"/> <input checked="" type="checkbox"/> <input checked="" type="checkbox"/> <input checked="" type="checkbox"/>