

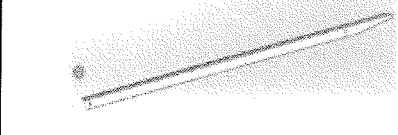

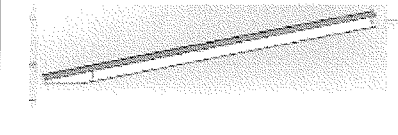

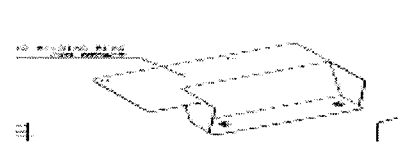

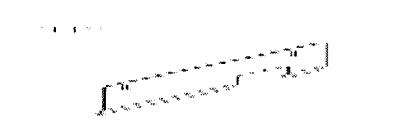

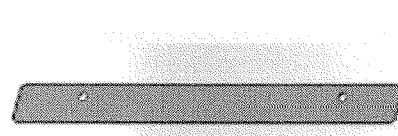
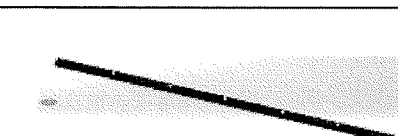
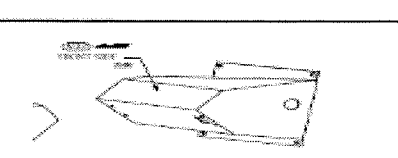
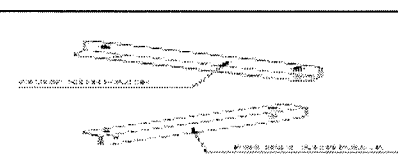
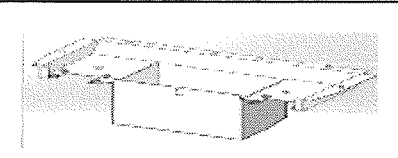
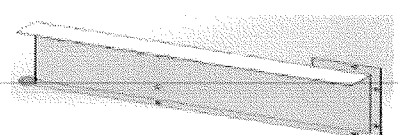
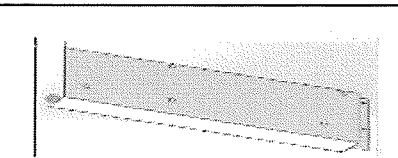
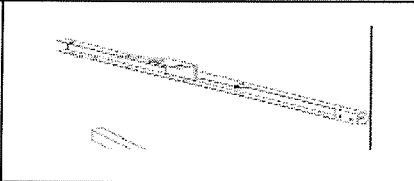
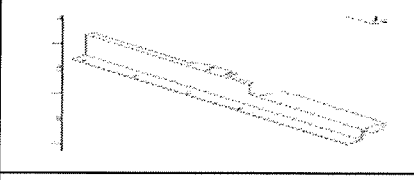
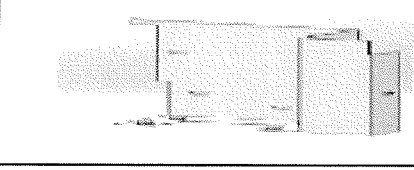
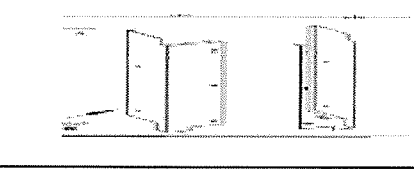
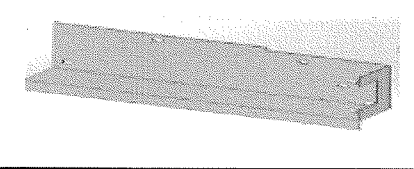
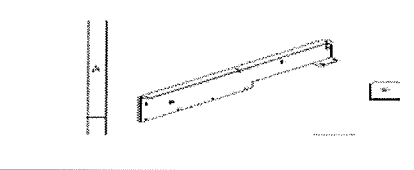
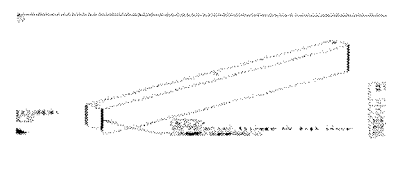
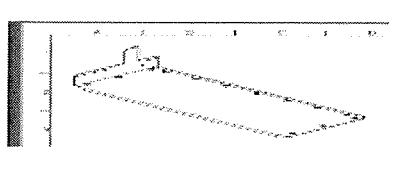
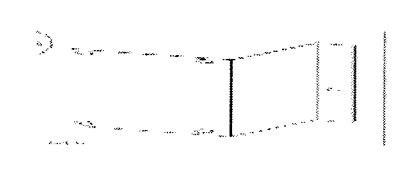
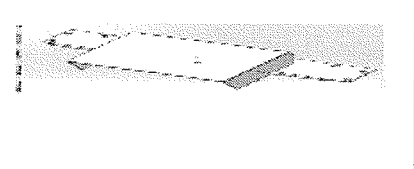
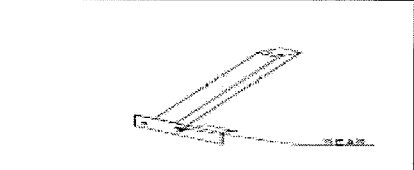
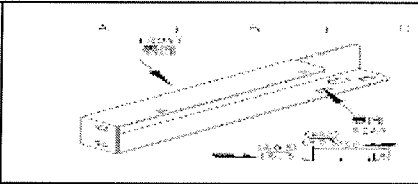
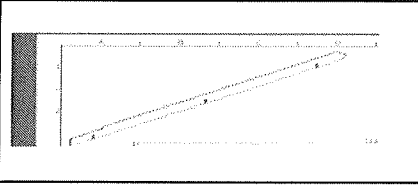
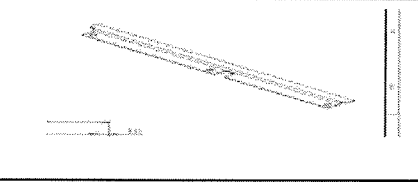
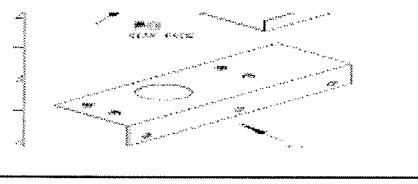
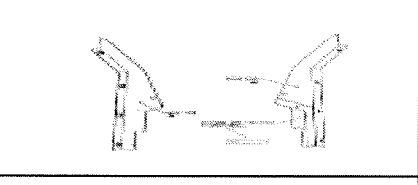
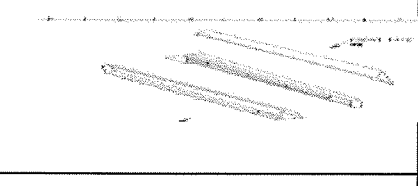
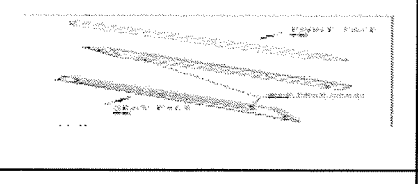
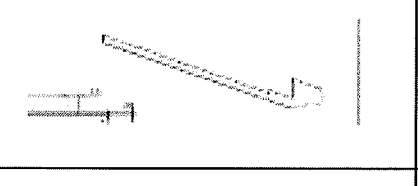
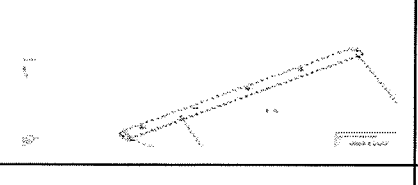
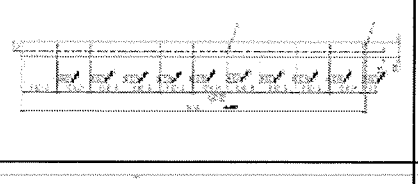
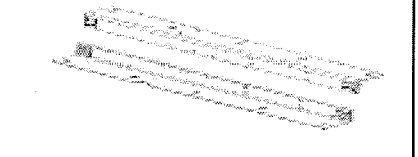

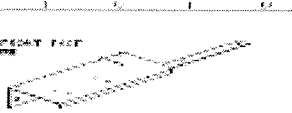

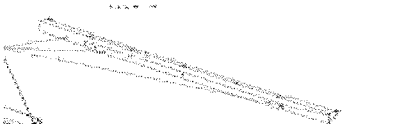
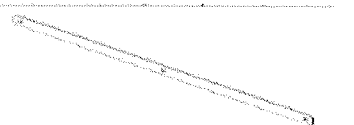
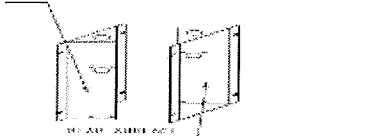
CMXC1240913第三十五批

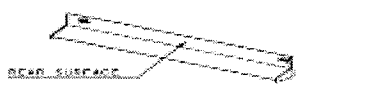
序号	物料号	内部号	简图	数量	颜色	检查内容	检查
1	H8106467A01	1		1	白皱/カルサイト トホワイト (凹凸) /9NT06835HL	①确认颜色正确 ②确认无毛刺	<input checked="" type="checkbox"/> <input checked="" type="checkbox"/>
2	H8106468A01	1		1	白皱/カルサイ トホワイト (凹凸) /9NT06835HL	①确认颜色正确 ②确认无毛刺	<input checked="" type="checkbox"/> <input checked="" type="checkbox"/>
3	H0704293B01	1		1	白皱/カルサイ トホワイト (凹凸) /9NT06835HL	确认颜色正确 确认无毛刺 确认无变形 过丝确认	<input checked="" type="checkbox"/> <input checked="" type="checkbox"/> <input checked="" type="checkbox"/> <input checked="" type="checkbox"/>
4	H0704295A02	1		1	白皱/カルサイ トホワイト (凹凸) /9NT06835HL	①确认颜色正确 ②确认无毛刺	<input checked="" type="checkbox"/> <input checked="" type="checkbox"/>
5	H3201662B01	1		2	黑平/黑 /9005HS50	①确认颜色正确 ②确认无毛刺	<input checked="" type="checkbox"/> <input checked="" type="checkbox"/>
6	H3201665A02	1		1	发丝	①确认颜色正确 ②确认无毛刺	<input checked="" type="checkbox"/> <input checked="" type="checkbox"/>
7	H8104543A02	1		1	白皱/カルサイ トホワイト /9NT06835HL	确认颜色正确 确认无毛刺 确认无变形 过丝确认	<input checked="" type="checkbox"/> <input checked="" type="checkbox"/> <input checked="" type="checkbox"/> <input checked="" type="checkbox"/>
8	H8105043A02	1		1	白皱/カルサイ トホワイト (凹凸) /9NT06835HL	确认颜色正确 确认无毛刺 确认无变形 过丝确认	<input checked="" type="checkbox"/> <input checked="" type="checkbox"/> <input checked="" type="checkbox"/> <input checked="" type="checkbox"/>
9	H8105065A01	1		1	发丝	①确认颜色正确 ②确认无毛刺	<input checked="" type="checkbox"/> <input checked="" type="checkbox"/>
10	H8105066A01	1		1	发丝	①确认颜色正确 ②确认无毛刺	<input checked="" type="checkbox"/> <input checked="" type="checkbox"/>
11	H8105067A01	1		1	发丝	①确认颜色正确 ②确认无毛刺	<input checked="" type="checkbox"/> <input checked="" type="checkbox"/>

12	H8105068A02	1		1	白皱/カルサイト トホワイト (凹凸) /9NT06835HL	①确认颜色正确 ②确认无毛刺	<input checked="" type="checkbox"/> <input checked="" type="checkbox"/>
13	H8105069A03	1		1	白皱/カルサイ トホワイト (凹凸) /9NT06835HL	①确认颜色正确 ②确认无毛刺	<input checked="" type="checkbox"/> <input checked="" type="checkbox"/>
14	H8105070A01	1		1	发丝	确认颜色正确 确认无毛刺 确认无变形 过丝确认	<input checked="" type="checkbox"/> <input checked="" type="checkbox"/> <input checked="" type="checkbox"/> <input checked="" type="checkbox"/>
15	H8105071B02	1		1	白皱/カルサイ トホワイト (凹凸) /9NT06835HL	确认颜色正确 确认无毛刺 确认无变形 过丝确认	<input checked="" type="checkbox"/> <input checked="" type="checkbox"/> <input checked="" type="checkbox"/> <input checked="" type="checkbox"/>
16	H8105073A01	1		1	发丝	①确认颜色正确 ②确认无毛刺	<input checked="" type="checkbox"/> <input checked="" type="checkbox"/>
17	H8105077B01	1		1	黑平/黑涂装 /9005HS50	①确认颜色正确 ②确认无毛刺	<input checked="" type="checkbox"/> <input checked="" type="checkbox"/>
18	H8105078A03	1		1	白皱/カルサイ トホワイト (凹凸) /9NT06835HL	①确认颜色正确 ②确认无毛刺	<input checked="" type="checkbox"/> <input checked="" type="checkbox"/>
19	H8105079A03	1		1	白皱/カルサイ トホワイト (凹凸) /9NT06835HL	确认颜色正确 确认无毛刺 确认无变形 过丝确认	<input checked="" type="checkbox"/> <input checked="" type="checkbox"/> <input checked="" type="checkbox"/> <input checked="" type="checkbox"/>
20	H8105094A01	1		1	黑皱/グラフ イトブラック (凹凸) /0NT00281HL	确认颜色正确 确认无毛刺 确认无变形 过丝确认	<input checked="" type="checkbox"/> <input checked="" type="checkbox"/> <input checked="" type="checkbox"/> <input checked="" type="checkbox"/>
21	H8105097A01	1		1	发丝	①确认颜色正确 ②确认无毛刺	<input checked="" type="checkbox"/> <input checked="" type="checkbox"/>
22	H8105101A02	1		1	黑平/黑涂装 /9005HS50	确认颜色正确 确认无毛刺 确认无变形 过丝确认	<input checked="" type="checkbox"/> <input checked="" type="checkbox"/> <input checked="" type="checkbox"/> <input checked="" type="checkbox"/>

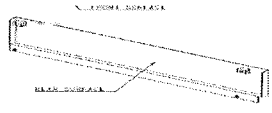
23	H8105118A03	1		1	黑平/黑色 /9005HS50	确认颜色正确 确认无毛刺 确认无变形 过丝确认	<input checked="" type="checkbox"/> <input checked="" type="checkbox"/> <input checked="" type="checkbox"/> <input checked="" type="checkbox"/>
24	H8105119A03	1		1	白皱/カルサイト トホワイト /9NT06835HL	①确认颜色正确 ②确认无毛刺	<input checked="" type="checkbox"/> <input checked="" type="checkbox"/>
25	H8105132A01	1		1	白皱/カルサイト トホワイト /9NT06835HL	①确认颜色正确 ②确认无毛刺	<input checked="" type="checkbox"/> <input checked="" type="checkbox"/>
26	H8105372A02	1		1	白皱/カルサ イトホワイト (凹凸) /9NT06835HL	确认颜色正确 确认无毛刺 确认无变形 过丝确认	<input checked="" type="checkbox"/> <input checked="" type="checkbox"/> <input checked="" type="checkbox"/> <input checked="" type="checkbox"/>
27	H8105575A01	1		1	白皱/カルサ イトホワイト (凹凸) /9NT06835HL	确认颜色正确 确认无毛刺 确认无变形 过丝确认	<input checked="" type="checkbox"/> <input checked="" type="checkbox"/> <input checked="" type="checkbox"/> <input checked="" type="checkbox"/>
28	H8106188A01	1		1	白皱/カルサ イトホワイト (凹凸) /9NT06835HL	①确认颜色正确 ②确认无毛刺	<input checked="" type="checkbox"/> <input checked="" type="checkbox"/>
29	H8106189A01	1		1	白皱/カルサ イトホワイト (凹凸) /9NT06835HL	①确认颜色正确 ②确认无毛刺	<input checked="" type="checkbox"/> <input checked="" type="checkbox"/>
30	H8106193A01	1		1	白皱/カルサ イトホワイト (凹凸) /9NT06835HL	①确认颜色正确 ②确认无毛刺	<input checked="" type="checkbox"/> <input checked="" type="checkbox"/>
31	SBF3034227A	1		1	表面抛光处理	①确认颜色正确 ②确认无毛刺	<input checked="" type="checkbox"/> <input checked="" type="checkbox"/>
32	B3001520A02	1		1	抹油	①确认颜色正确 ②确认无毛刺	<input checked="" type="checkbox"/> <input checked="" type="checkbox"/>
33	B6802783A03	1		1	黑平/黑色 /9005HS50	确认颜色正确 确认无毛刺 确认无变形 过丝确认	<input checked="" type="checkbox"/> <input checked="" type="checkbox"/> <input checked="" type="checkbox"/> <input checked="" type="checkbox"/>

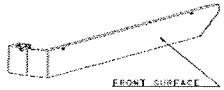
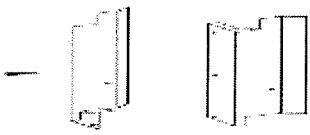
34	B7702401A04	1		1	黒平/黒色 /9005HS50	確認颜色正确 確認无毛刺 確認无变形 过丝确认	<input checked="" type="checkbox"/> <input checked="" type="checkbox"/> <input checked="" type="checkbox"/> <input checked="" type="checkbox"/>	
35	B7702402D01	1		1	黒平/黒色 /9005HS50	確認颜色正确 確認无毛刺 確認无变形 过丝确认	<input checked="" type="checkbox"/> <input checked="" type="checkbox"/> <input checked="" type="checkbox"/> <input checked="" type="checkbox"/>	
36	H0003431B01	1		1	白皱/カルサイト トホワイト /9NT06835HL	①確認颜色正确 ②確認无毛刺	<input checked="" type="checkbox"/> <input checked="" type="checkbox"/>	
37	H0103650B01	1		1	白皱/カルサイト トホワイト /9NT06835HL	①確認颜色正确 ②確認无毛刺	<input checked="" type="checkbox"/> <input checked="" type="checkbox"/>	
38	H0504966A01	1		1	巴扑	①確認颜色正确 ②確認无毛刺	<input checked="" type="checkbox"/> <input checked="" type="checkbox"/>	
39	H3201661B01	1		2	黒平/黒色 /9005HS50	①確認颜色正确 ②確認无毛刺	<input checked="" type="checkbox"/> <input checked="" type="checkbox"/>	
40	H8105055A02	1		1	白皱/カルサイト トホワイト (凹凸) /9NT06835HL	確認颜色正确 確認无毛刺 確認无变形 过丝确认	<input checked="" type="checkbox"/> <input checked="" type="checkbox"/> <input checked="" type="checkbox"/> <input checked="" type="checkbox"/>	
41	H8105063C01	1		1	巴扑	①確認颜色正确 ②確認无毛刺	<input checked="" type="checkbox"/> <input checked="" type="checkbox"/>	
42	H8105225A02	1		1	巴扑	①確認颜色正确 ②確認无毛刺	<input checked="" type="checkbox"/> <input checked="" type="checkbox"/>	
43	H8105875A01	1		1	白皱/カルサイト トホワイト (凹凸) /9NT06835HL	確認颜色正确 確認无毛刺 確認无变形 过丝确认	<input checked="" type="checkbox"/> <input checked="" type="checkbox"/> <input checked="" type="checkbox"/> <input checked="" type="checkbox"/>	
44	H8106191A01	1		1	黒皱/グラフィ イトブラック (凹凸) /0NT00281HL	①確認颜色正确 ②確認无毛刺	<input checked="" type="checkbox"/> <input checked="" type="checkbox"/>	

45	H8105853A01	1		1	白皱/カルサイトホワイト /9NT06835HL	确认颜色正确 确认无毛刺 确认无变形 过丝确认	<input checked="" type="checkbox"/> <input checked="" type="checkbox"/> <input checked="" type="checkbox"/> <input checked="" type="checkbox"/>	
46	H8105877A01	1		1	白皱/カルサイトホワイト (凹凸) /9NT06835HL	①确认颜色正确 ②确认无毛刺	<input checked="" type="checkbox"/> <input checked="" type="checkbox"/>	
47	H8105879A01	1		1	黑皱/グラフィットブラック (凹凸) /0NT00281HL	确认颜色正确 确认无毛刺 确认无变形 过丝确认	<input checked="" type="checkbox"/> <input checked="" type="checkbox"/> <input checked="" type="checkbox"/> <input checked="" type="checkbox"/>	
48	5246402	1		1	白皱/カルサイトホワイト (凹凸) /9NT06835HL	确认颜色正确 确认无毛刺 确认无变形 过丝确认	<input checked="" type="checkbox"/> <input checked="" type="checkbox"/> <input checked="" type="checkbox"/> <input checked="" type="checkbox"/>	
49	5295881	1		1	白皱/カルサイトホワイト /9NT06835HL	①确认颜色正确 ②确认无毛刺	<input checked="" type="checkbox"/> <input checked="" type="checkbox"/>	刘春哥