

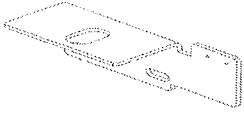

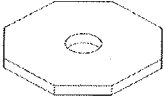







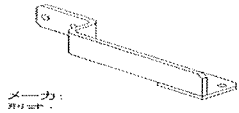
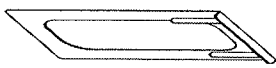
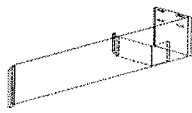
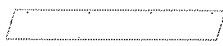

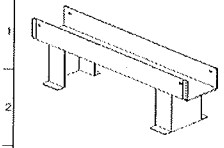
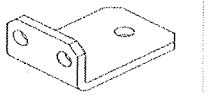

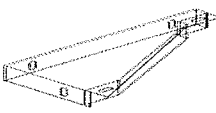
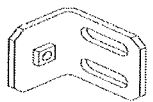
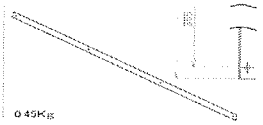
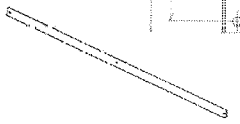





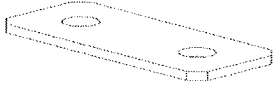
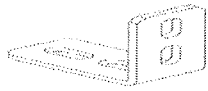

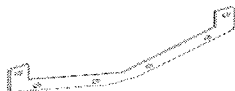



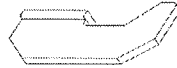

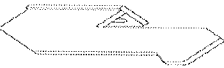

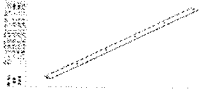
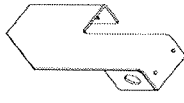

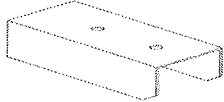



LPP63241001 (第三十三批)



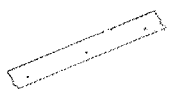

序号	内部号	型式	简图	数量	颜色		检查
1	3	5144928		1	灰平	确认颜色正确 确认无毛刺	<input checked="" type="checkbox"/> <input checked="" type="checkbox"/> ALR
2	3	5144685		4	白平	确认颜色正确 确认无毛刺	<input checked="" type="checkbox"/> <input checked="" type="checkbox"/> ALW
3	3	5144811		1	白平	确认颜色正确 确认无毛刺 确认挂钩点处理	<input checked="" type="checkbox"/> <input checked="" type="checkbox"/> <input checked="" type="checkbox"/> ALW
4	3	5144812		1	白平	确认颜色正确 确认无毛刺 过丝确认	<input checked="" type="checkbox"/> <input checked="" type="checkbox"/> <input checked="" type="checkbox"/> ALW
5	3	5144815		1	白平	确认颜色正确 确认无毛刺 过丝确认	<input checked="" type="checkbox"/> <input checked="" type="checkbox"/> <input checked="" type="checkbox"/> ALW
6	3	5144686		8	白平	确认颜色正确 确认挂钩点处理 确认无毛刺认	<input checked="" type="checkbox"/> <input checked="" type="checkbox"/> <input checked="" type="checkbox"/> ALW
7	3	5144696		1	白平	确认颜色正确 确认无毛刺 确认无变形	<input checked="" type="checkbox"/> <input checked="" type="checkbox"/> <input checked="" type="checkbox"/> ALW
8	3	5144698		1	白平	确认颜色正确 确认挂钩点处理 确认无毛刺认	<input checked="" type="checkbox"/> <input checked="" type="checkbox"/> <input checked="" type="checkbox"/> ALW
9	3	5144753		1	白平	确认颜色正确 确认挂钩点处理 确认无毛刺认	<input checked="" type="checkbox"/> <input checked="" type="checkbox"/> <input checked="" type="checkbox"/> ALW
10	3	5144817		1	白平	确认颜色正确 确认挂钩点处理 确认无毛刺认	<input checked="" type="checkbox"/> <input checked="" type="checkbox"/> <input checked="" type="checkbox"/> ALW
11	3	5144832		1	白平	确认颜色正确 确认挂钩点处理 确认无毛刺认	<input checked="" type="checkbox"/> <input checked="" type="checkbox"/> <input checked="" type="checkbox"/> ALW

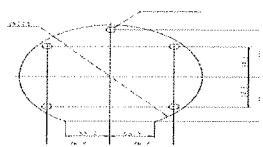
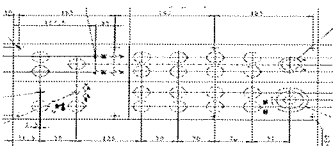
12	3	5144833		2	白平	确认颜色正确 确认挂钩点处理 确认无毛刺认	<input type="checkbox"/> <input checked="" type="checkbox"/> <input checked="" type="checkbox"/>	ALW
13	3	5217736		1	白平	确认颜色正确 确认无毛刺 过丝确认	<input checked="" type="checkbox"/> <input checked="" type="checkbox"/> <input checked="" type="checkbox"/>	ALW
14	3	5144820		2	白平	确认颜色正确 确认挂钩点处理 确认无毛刺认	<input checked="" type="checkbox"/> <input checked="" type="checkbox"/> <input checked="" type="checkbox"/>	ALW
15	3	5144750		1	白平	确认颜色正确 确认挂钩点处理 确认无毛刺认	<input checked="" type="checkbox"/> <input checked="" type="checkbox"/> <input checked="" type="checkbox"/>	ALW
16	3	5144769		1	白皱	确认颜色正确 确认无毛刺 过丝确认	<input checked="" type="checkbox"/> <input checked="" type="checkbox"/> <input checked="" type="checkbox"/>	ALW
17	3	5144791		2	黑色	确认颜色正确 确认挂钩点处理 确认无毛刺认	<input checked="" type="checkbox"/> <input checked="" type="checkbox"/> <input checked="" type="checkbox"/>	ALW
18	3	5144792		2	黑色	确认颜色正确 确认无变形 过丝无毛刺	<input checked="" type="checkbox"/> <input checked="" type="checkbox"/> <input checked="" type="checkbox"/>	ALW
19	3	5144742		1	白平	确认颜色正确 确认无毛刺 过丝确认	<input checked="" type="checkbox"/> <input checked="" type="checkbox"/> <input checked="" type="checkbox"/>	ALW
20	3	5144749		1	白平	确认颜色正确 确认无变形 过丝无毛刺	<input checked="" type="checkbox"/> <input checked="" type="checkbox"/> <input checked="" type="checkbox"/>	ALW
21	3	5144582		8	灰平	确认颜色正确 确认无变形 过丝无毛刺	<input checked="" type="checkbox"/> <input checked="" type="checkbox"/> <input checked="" type="checkbox"/>	WSA
22	3	5144568		4	灰平	确认颜色正确 确认无变形 过丝无毛刺	<input checked="" type="checkbox"/> <input checked="" type="checkbox"/> <input checked="" type="checkbox"/>	WSA



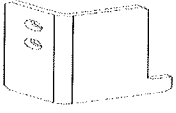
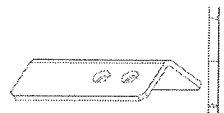

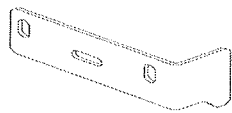
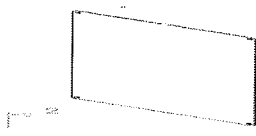
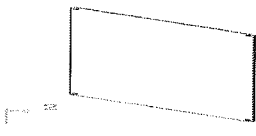
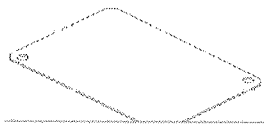
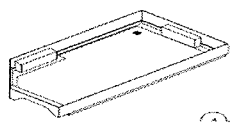

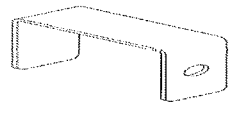
23	3	5144569		3	灰平	确认颜色正确 确认无变形 过丝无毛刺	<input checked="" type="checkbox"/> <input checked="" type="checkbox"/> <input checked="" type="checkbox"/>	WSA
24	3	5144571		8	灰平	确认颜色正确 确认无毛刺 过丝确认	<input checked="" type="checkbox"/> <input checked="" type="checkbox"/> <input type="checkbox"/>	WSA
25	3	5144847		2	白平	确认颜色正确 确认无毛刺	<input checked="" type="checkbox"/> <input type="checkbox"/>	LDA
26	3	5144848		2	白平	确认颜色正确 确认无变形 过丝无毛刺	<input type="checkbox"/> <input checked="" type="checkbox"/> <input checked="" type="checkbox"/>	LDA
27	3	5144849		2	白平	确认颜色正确 确认无变形 过丝无毛刺	<input checked="" type="checkbox"/> <input checked="" type="checkbox"/> <input checked="" type="checkbox"/>	LDA
28	3	5144888		11	黑色材料	①确认颜色正确 ②确认无毛刺	<input checked="" type="checkbox"/> <input checked="" type="checkbox"/>	LCA
29	3	5145104		1	白皱	确认颜色正确 确认无变形 确认无毛刺	<input checked="" type="checkbox"/> <input checked="" type="checkbox"/> <input type="checkbox"/>	LCO
30	3	5144058		1	不要	确认无变形, 划伤 确认无毛刺	<input type="checkbox"/> <input checked="" type="checkbox"/>	AYL
31	3	5144062		1	不要	确认无变形, 划伤 确认无毛刺	<input checked="" type="checkbox"/> <input checked="" type="checkbox"/>	AYL
32	3	5144082		1	灰平	确认颜色正确 确认无变形 确认无毛刺	<input checked="" type="checkbox"/> <input checked="" type="checkbox"/> <input type="checkbox"/>	AYL
33	3	5144538		1	灰平	确认颜色正确 确认无毛刺	<input checked="" type="checkbox"/> <input checked="" type="checkbox"/>	AZL

34	3	5144539		1	灰平	确认颜色正确 确认无毛刺	<input checked="" type="checkbox"/> <input checked="" type="checkbox"/>	AZL
35	3	5144540		1	灰平	确认颜色正确 确认无毛刺	<input checked="" type="checkbox"/> <input checked="" type="checkbox"/>	AZL
36	3	5144541		1	灰平	确认颜色正确 确认无毛刺	<input checked="" type="checkbox"/> <input checked="" type="checkbox"/>	AZL
37	3	5144543		1	灰平	确认颜色正确 确认无毛刺	<input checked="" type="checkbox"/> <input checked="" type="checkbox"/>	AZL
38	3	5144544		2	灰平	确认颜色正确 确认无毛刺	<input checked="" type="checkbox"/> <input checked="" type="checkbox"/>	AZL
39	3	5144546		1	灰平	确认颜色正确 确认无毛刺	<input checked="" type="checkbox"/> <input checked="" type="checkbox"/>	AZL
40	3	5144547		1	灰平	确认颜色正确 确认无变形 过丝无毛刺	<input checked="" type="checkbox"/> <input checked="" type="checkbox"/> <input checked="" type="checkbox"/>	AZL
41	3	5144548		2	灰平	确认颜色正确 确认无毛刺	<input checked="" type="checkbox"/> <input checked="" type="checkbox"/>	AZL
42	3	5144550		1	灰平	确认颜色正确 确认无毛刺	<input checked="" type="checkbox"/> <input checked="" type="checkbox"/>	AZL
43	3	5144551		20	不要	确认无变形, 划伤 确认无毛刺	<input checked="" type="checkbox"/> <input checked="" type="checkbox"/>	AZL
44	3	5298971		2	不要	确认无变形, 划伤 确认无毛刺	<input checked="" type="checkbox"/> <input checked="" type="checkbox"/>	AZL

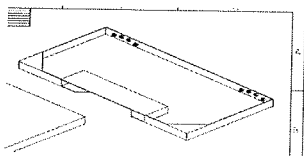
45	3	5144553		2	不要	确认无变形, 划伤 确认无毛刺	<input checked="" type="checkbox"/> <input checked="" type="checkbox"/>	AZL
46	3	5144554		1	灰平	确认颜色正确 确认无变形 过丝无毛刺	<input checked="" type="checkbox"/> <input checked="" type="checkbox"/> <input checked="" type="checkbox"/>	AZL
47	3	5144560		1	灰平	确认颜色正确 确认无变形 过丝无毛刺	<input checked="" type="checkbox"/> <input checked="" type="checkbox"/> <input checked="" type="checkbox"/>	AZL
48	3	5144555		1	灰平	确认颜色正确 确认无毛刺	<input checked="" type="checkbox"/> <input checked="" type="checkbox"/>	AZL
49	3	5144556		20	不要	确认颜色正确 确认无毛刺	<input checked="" type="checkbox"/> <input checked="" type="checkbox"/>	AZL
50	3	5144558		1	灰平	确认颜色正确 确认无毛刺	<input checked="" type="checkbox"/> <input checked="" type="checkbox"/>	AZL
51	3	5144559		1	灰平	确认颜色正确 确认无毛刺	<input checked="" type="checkbox"/> <input checked="" type="checkbox"/>	AZL
52	3	5144561		1	灰平	确认颜色正确 确认无毛刺	<input checked="" type="checkbox"/> <input checked="" type="checkbox"/>	AZL
53	3	5144752		1	白平	确认颜色正确 确认挂钩点处理 过丝无毛刺	<input checked="" type="checkbox"/> <input checked="" type="checkbox"/> <input checked="" type="checkbox"/>	ALW
54	3	5144762		1	白皱	确认颜色正确 确认无毛刺 过丝确认	<input checked="" type="checkbox"/> <input checked="" type="checkbox"/> <input checked="" type="checkbox"/>	ALW
55	3	5144763		1	白皱	确认颜色正确 确认挂钩点处理 确认无毛刺	<input checked="" type="checkbox"/> <input checked="" type="checkbox"/> <input checked="" type="checkbox"/>	ALW

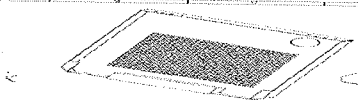
56	3	5144764		1	黒染め	①确认黒染外观 ②确认无毛刺	<input checked="" type="checkbox"/> <input checked="" type="checkbox"/>	ALW
57	3	5144765		1	黒染め	①确认黒染外观 ②确认无毛刺	<input checked="" type="checkbox"/> <input checked="" type="checkbox"/>	ALW
58	3	5144766		1	白皱	确认颜色正确 确认无毛刺 过丝确认	<input checked="" type="checkbox"/> <input checked="" type="checkbox"/> <input checked="" type="checkbox"/>	ALW
59	3	5144767		1	黒染め	①确认颜色正确 ②确认无毛刺	<input checked="" type="checkbox"/> <input checked="" type="checkbox"/>	ALW
60	3	5144768		1	黒染め	确认黒染外观 确认无毛刺	<input checked="" type="checkbox"/> <input checked="" type="checkbox"/>	ALW
61	3	5145093		3	透明	确认切面平整无毛刺 确认无毛刺	<input checked="" type="checkbox"/> <input checked="" type="checkbox"/>	SPP
62	3	5145109		1	白平	确认颜色正确 确认挂钩点处理 确认无毛刺	<input checked="" type="checkbox"/> <input checked="" type="checkbox"/> <input checked="" type="checkbox"/>	ALW
63	3	5145110		1	白皱	确认颜色正确 确认无变形 确认无变形	<input checked="" type="checkbox"/> <input checked="" type="checkbox"/> <input checked="" type="checkbox"/>	ALW
64	3	5145092		1	透明	确认切面平整无毛刺 确认无毛刺	<input checked="" type="checkbox"/> <input checked="" type="checkbox"/>	SPP
65	3	H1U075A02		2	灰平	确认颜色正确 确认挂钩点处理 确认无毛刺	<input checked="" type="checkbox"/> <input checked="" type="checkbox"/> <input checked="" type="checkbox"/>	ALW
66	3	5144926		2	灰平	确认颜色正确 确认无毛刺	<input checked="" type="checkbox"/> <input checked="" type="checkbox"/>	ALR

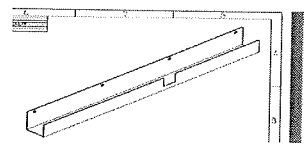
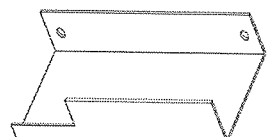
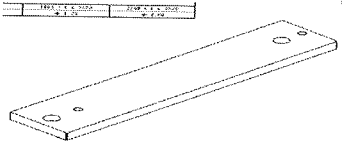
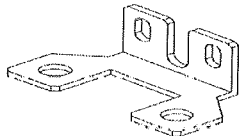
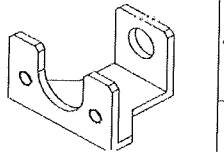
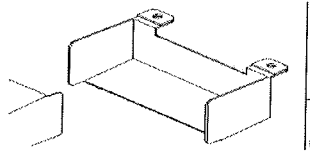
67	3	5144923		2	灰平	确认颜色正确 确认无毛刺	<input checked="" type="checkbox"/> <input type="checkbox"/>	ALR
68	3	5237729		1	灰平	确认颜色正确 确认无变形 过丝无毛刺	<input checked="" type="checkbox"/> <input checked="" type="checkbox"/> <input checked="" type="checkbox"/>	AZL
69	3	5237730		1	灰平	确认颜色正确 确认无变形 过丝无毛刺	<input checked="" type="checkbox"/> <input checked="" type="checkbox"/> <input checked="" type="checkbox"/>	AZL
70	3	5298970		1	灰平	确认颜色正确 确认无毛刺	<input checked="" type="checkbox"/> <input checked="" type="checkbox"/>	AZL
71	3	5358375		1	白皱	确认颜色正确 确认无毛刺	<input checked="" type="checkbox"/> <input checked="" type="checkbox"/>	ALW
72	3	5381275		1	白皱	确认颜色正确 确认无变形 确认无毛刺	<input checked="" type="checkbox"/> <input checked="" type="checkbox"/> <input checked="" type="checkbox"/>	ALW
73	3	5513103		22	灰平	确认颜色正确 确认无毛刺	<input checked="" type="checkbox"/> <input type="checkbox"/>	WSA
74	3	5513736		1	白皱	确认颜色正确 确认无变形 过丝无毛刺	<input checked="" type="checkbox"/> <input checked="" type="checkbox"/> <input checked="" type="checkbox"/>	ALW
75	3	5549844		2		确认颜色正确 确认无毛刺 过丝确认	<input checked="" type="checkbox"/> <input type="checkbox"/> <input type="checkbox"/> <input checked="" type="checkbox"/>	ALW
76	3	5549863		1	白皱	确认颜色正确 确认无毛刺 过丝确认	<input checked="" type="checkbox"/> <input checked="" type="checkbox"/> <input checked="" type="checkbox"/>	ALW
77	3	5366039		1	黑平	确认颜色正确 确认无变形 过丝无毛刺 确认无变形	<input checked="" type="checkbox"/> <input checked="" type="checkbox"/> <input checked="" type="checkbox"/> <input checked="" type="checkbox"/>	ALW

89	3	5413205		1	黑平	确认颜色正确 确认无毛刺 确认无变形	<input type="checkbox"/> <input checked="" type="checkbox"/> <input checked="" type="checkbox"/>	ALW
90	3	5388743		1	白平	确认颜色正确 确认无毛刺 确认无变形	<input checked="" type="checkbox"/> <input checked="" type="checkbox"/> <input checked="" type="checkbox"/>	ALW
91	3	5413203		1	黑平	确认颜色正确 确认无毛刺 确认无变形	<input type="checkbox"/> <input checked="" type="checkbox"/> <input checked="" type="checkbox"/>	ALW
92	3	5388736		1	白平	确认颜色正确 确认无毛刺 确认无变形	<input checked="" type="checkbox"/> <input checked="" type="checkbox"/> <input checked="" type="checkbox"/>	ALW
93	3	5366732		1	黑平	确认颜色正确 确认无毛刺 确认无变形	<input checked="" type="checkbox"/> <input checked="" type="checkbox"/> <input checked="" type="checkbox"/>	ALW
94	3	5366745		1	黑平	确认颜色正确 确认无毛刺 确认无变形	<input checked="" type="checkbox"/> <input checked="" type="checkbox"/> <input checked="" type="checkbox"/>	ALW
95	3	5388691		1		确认颜色正确 确认无毛刺 确认无变形	<input checked="" type="checkbox"/> <input checked="" type="checkbox"/> <input checked="" type="checkbox"/>	ALW
96	3	5500279		1	白皱	确认颜色正确 确认无毛刺 确认无变形	<input checked="" type="checkbox"/> <input checked="" type="checkbox"/> <input checked="" type="checkbox"/>	ALW
97	3	5500280		1	白皱	确认颜色正确 确认无毛刺 确认无变形	<input checked="" type="checkbox"/> <input checked="" type="checkbox"/> <input checked="" type="checkbox"/>	ALW
98	3	5500281		1	白皱	确认颜色正确 确认无毛刺 确认无变形	<input checked="" type="checkbox"/> <input checked="" type="checkbox"/> <input checked="" type="checkbox"/>	ALW
99	3	5553551		1		确认颜色正确 确认无毛刺 确认无变形	<input checked="" type="checkbox"/> <input checked="" type="checkbox"/> <input checked="" type="checkbox"/>	ALW

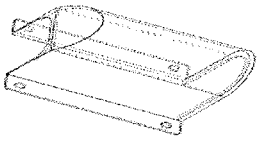
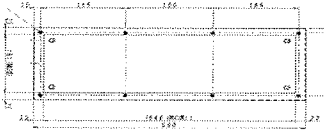
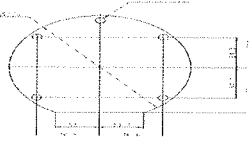
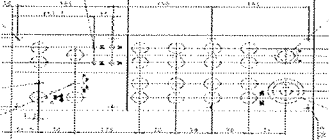
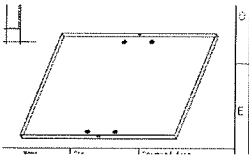
100	3	5553552		1	白皱	确认颜色正确 确认无毛刺 确认无变形	<input checked="" type="checkbox"/> <input checked="" type="checkbox"/> <input checked="" type="checkbox"/>	ALW
101	3	5556770		1	白平	确认颜色正确 确认无毛刺 确认无变形	<input type="checkbox"/> <input checked="" type="checkbox"/> <input checked="" type="checkbox"/>	ALW
102	3	5561545			灰平	确认颜色正确 确认无毛刺 确认无变形	<input checked="" type="checkbox"/> <input checked="" type="checkbox"/> <input checked="" type="checkbox"/>	ALW
103	3	5556769		1	黑平	确认颜色正确 确认无毛刺 确认无变形	<input checked="" type="checkbox"/> <input checked="" type="checkbox"/> <input checked="" type="checkbox"/>	ALW
104	3	5556771		1	黑平	确认颜色正确 确认无毛刺 确认无变形	<input checked="" type="checkbox"/> <input checked="" type="checkbox"/> <input checked="" type="checkbox"/>	刘春哥