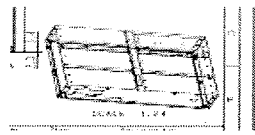
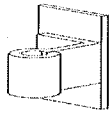
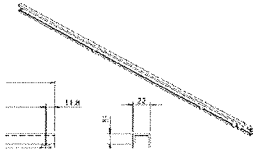
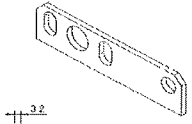
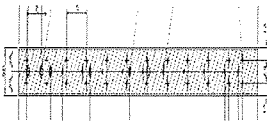
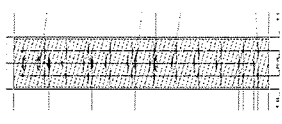
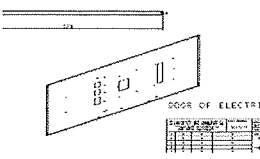
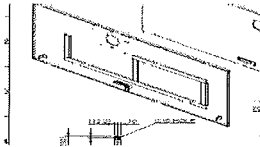
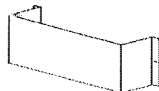
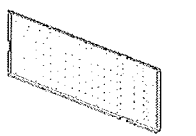
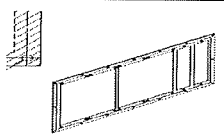
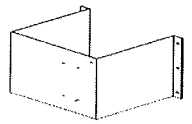
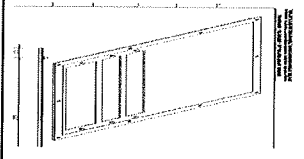
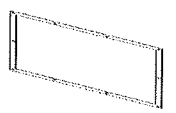
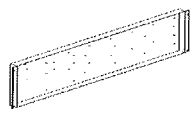
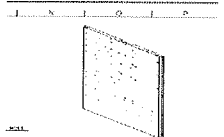
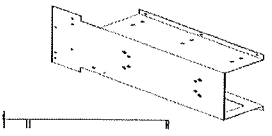
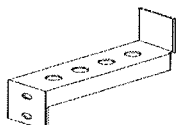
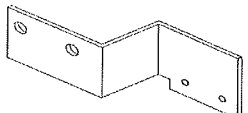
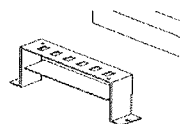
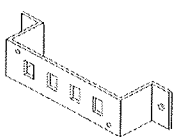
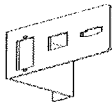
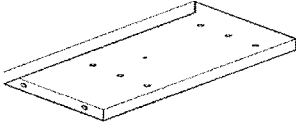
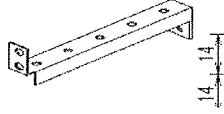
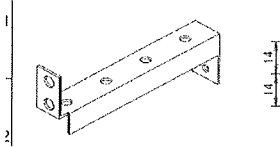
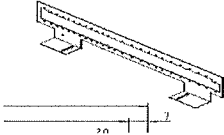
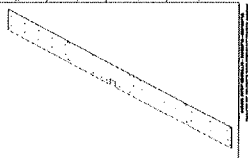
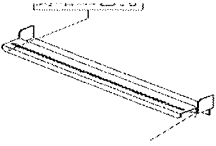
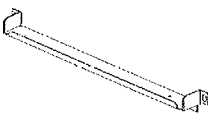
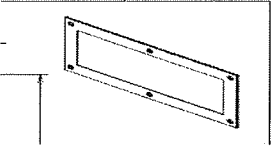
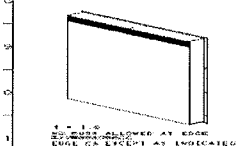
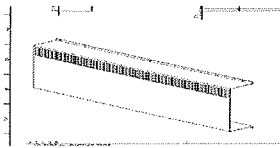
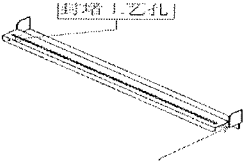
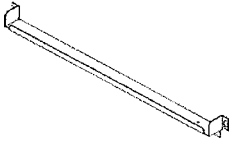
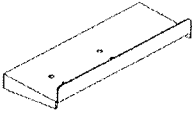
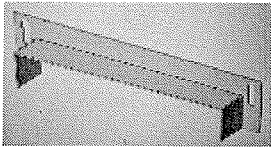
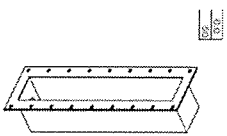
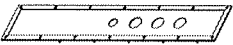
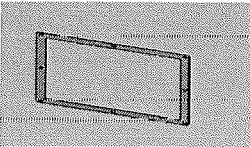
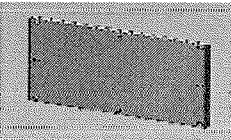
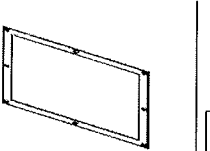
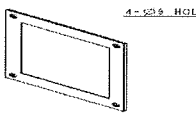
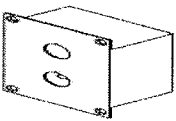

NHC10240501电柜- (第二十七批)

序号	内部号	型式	简图	数量	颜色	检测内容	备注	
1	4654	5449492		1	灰皱	确认颜色正确 确认无毛刺 确认无变形 过丝确认	<input checked="" type="checkbox"/> <input checked="" type="checkbox"/> <input checked="" type="checkbox"/> <input checked="" type="checkbox"/>	装配
2	4655	H2601868A01		4	灰皱	①确认颜色正确 ②确认无毛刺	<input checked="" type="checkbox"/> <input checked="" type="checkbox"/>	装配
3	4656	H2601869A01		1	灰皱	①确认颜色正确 ②确认无毛刺	<input checked="" type="checkbox"/> <input checked="" type="checkbox"/>	装配
4	4657	H2601870A01		2	灰皱	①确认颜色正确 ②确认无毛刺	<input checked="" type="checkbox"/> <input checked="" type="checkbox"/>	装配
5	4658	H2601884A01		2	三阶电镀	确认颜色正确 确认无毛刺 确认无变形 过丝确认	<input checked="" type="checkbox"/> <input checked="" type="checkbox"/> <input checked="" type="checkbox"/> <input checked="" type="checkbox"/>	装配
6	4659	H2601890A01		1	三阶电镀	确认颜色正确 确认无毛刺 确认无变形 过丝确认	<input checked="" type="checkbox"/> <input checked="" type="checkbox"/> <input checked="" type="checkbox"/> <input checked="" type="checkbox"/>	装配
7	3724	H2601853A01	无图贴在3722柜体上	4	三阶电镀	①确认颜色正确 ②确认无毛刺	<input checked="" type="checkbox"/> <input checked="" type="checkbox"/>	装配
8	4660	5212277		1	灰皱	确认颜色正确 确认无毛刺 确认无变形 过丝确认	<input checked="" type="checkbox"/> <input checked="" type="checkbox"/> <input checked="" type="checkbox"/> <input checked="" type="checkbox"/>	装配
9	4664	H2601873A02		1	灰皱	确认颜色正确 确认无毛刺 确认无变形 过丝确认	<input checked="" type="checkbox"/> <input checked="" type="checkbox"/> <input checked="" type="checkbox"/> <input checked="" type="checkbox"/>	装配
10	3729	H2A959A01		1	三阶电镀	①确认颜色正确 ②确认无毛刺	<input checked="" type="checkbox"/> <input checked="" type="checkbox"/>	装配
11	4666	H2601874A01		1	三阶电镀	确认颜色正确 确认无毛刺 确认无变形 过丝确认	<input checked="" type="checkbox"/> <input checked="" type="checkbox"/> <input checked="" type="checkbox"/> <input checked="" type="checkbox"/>	装配

12	4667	H2601875A01		1	三阶电镀	确认颜色正确 确认无毛刺 确认无变形 过丝确认	<input checked="" type="checkbox"/> <input checked="" type="checkbox"/> <input checked="" type="checkbox"/> <input checked="" type="checkbox"/>	装配
13	4668	H2601876A01		1	三阶电镀	确认颜色正确 确认无毛刺 确认无变形 过丝确认	<input checked="" type="checkbox"/> <input checked="" type="checkbox"/> <input checked="" type="checkbox"/> <input checked="" type="checkbox"/>	装配
14	4669	H2601878B01		1	三阶电镀	确认颜色正确 确认无毛刺 确认无变形 过丝确认	<input checked="" type="checkbox"/> <input checked="" type="checkbox"/> <input checked="" type="checkbox"/> <input checked="" type="checkbox"/>	装配
15	4671	X33470B01		1	三阶电镀	①确认颜色正确 ②确认无毛刺	<input checked="" type="checkbox"/> <input checked="" type="checkbox"/>	装配
16	4672	H2601883A02		1	三阶电镀	确认颜色正确 确认无毛刺 确认无变形 过丝确认	<input checked="" type="checkbox"/> <input checked="" type="checkbox"/> <input checked="" type="checkbox"/> <input checked="" type="checkbox"/>	装配
17	4673	H2601880A02		1	三阶电镀	确认颜色正确 确认无毛刺 确认无变形 过丝确认	<input checked="" type="checkbox"/> <input checked="" type="checkbox"/> <input checked="" type="checkbox"/> <input checked="" type="checkbox"/>	装配
18	4674	H2602034A01		1	三阶电镀	确认颜色正确 确认无毛刺 确认无变形 过丝确认	<input checked="" type="checkbox"/> <input checked="" type="checkbox"/> <input checked="" type="checkbox"/> <input checked="" type="checkbox"/>	装配
19	4675	H2A947A03		1	三阶电镀	①确认颜色正确 ②确认无毛刺	<input checked="" type="checkbox"/> <input checked="" type="checkbox"/>	装配
20	4676	5494824		1	三阶电镀	①确认颜色正确 ②确认无毛刺	<input checked="" type="checkbox"/> <input checked="" type="checkbox"/>	装配
21	4677	H2601881A01		1	三阶电镀	①确认颜色正确 ②确认无毛刺	<input checked="" type="checkbox"/> <input checked="" type="checkbox"/>	装配
22	4678	H2601882A01		1	三阶电镀	①确认颜色正确 ②确认无毛刺	<input checked="" type="checkbox"/> <input checked="" type="checkbox"/>	装配

23	4679	H2B019A01		1	三阶电镀	①确认颜色正确 ②确认无毛刺	<input checked="" type="checkbox"/> <input checked="" type="checkbox"/>	装配
24	4680	H2601871A01		1	三阶电镀	①确认颜色正确 ②确认无毛刺	<input checked="" type="checkbox"/> <input checked="" type="checkbox"/>	装配
25	4681	H2B021B01		5	三阶电镀	①确认颜色正确 ②确认无毛刺	<input checked="" type="checkbox"/> <input checked="" type="checkbox"/>	装配
26	4682	H2B022B01		1	三阶电镀	①确认颜色正确 ②确认无毛刺	<input checked="" type="checkbox"/> <input checked="" type="checkbox"/>	装配
27	4683	5169271		1	三阶电镀	确认颜色正确 确认无毛刺 确认无变形 过丝确认	<input checked="" type="checkbox"/> <input checked="" type="checkbox"/> <input checked="" type="checkbox"/> <input checked="" type="checkbox"/>	装配
28	4684	H2602035A01		1	三阶电镀	确认颜色正确 确认无毛刺 确认无变形 过丝确认	<input checked="" type="checkbox"/> <input checked="" type="checkbox"/> <input checked="" type="checkbox"/> <input checked="" type="checkbox"/>	装配
29	4687	H2601051A01		1	三阶电镀	确认颜色正确 确认无毛刺 确认无变形 过丝确认	<input checked="" type="checkbox"/> <input checked="" type="checkbox"/> <input checked="" type="checkbox"/> <input checked="" type="checkbox"/>	装配
30	4688	H2601052A01		1	三阶电镀	①确认颜色正确 ②确认无毛刺	<input checked="" type="checkbox"/> <input checked="" type="checkbox"/>	装配
31	4689	H2601886A01		2	灰皱	①确认颜色正确 ②确认无毛刺	<input checked="" type="checkbox"/> <input checked="" type="checkbox"/>	装配
32	4690	H2601887B01		1	灰皱	确认颜色正确 确认无毛刺 确认无变形 过丝确认	<input checked="" type="checkbox"/> <input checked="" type="checkbox"/> <input checked="" type="checkbox"/> <input checked="" type="checkbox"/>	装配
33	4692	H2601891A01		1	灰皱	确认颜色正确 确认无毛刺 确认无变形 过丝确认	<input checked="" type="checkbox"/> <input checked="" type="checkbox"/> <input checked="" type="checkbox"/> <input checked="" type="checkbox"/>	装配

34	4693	H2A960A01		1	三阶电镀	①确认颜色正确 ②确认无毛刺	<input checked="" type="checkbox"/>	装配
35	4694	H2A961A02		1	三阶电镀	①确认颜色正确 ②确认无毛刺	<input checked="" type="checkbox"/>	装配
36	4695	H2601895A01		2	灰皱	①确认颜色正确 ②确认无毛刺	<input checked="" type="checkbox"/>	装配
37	3730	H2601782A01		2	三阶电镀	①确认颜色正确 ②确认无毛刺	<input checked="" type="checkbox"/>	装配
38	3759	H2601776A02		1	灰皱	确认颜色正确 确认无毛刺 确认无变形 过丝确认	<input checked="" type="checkbox"/>	装配
39	4696	5112632		1	黑皱	确认颜色正确 确认无毛刺 确认无变形 过丝确认	<input checked="" type="checkbox"/>	装配
40	4378	H1100637A01		1	黑平	①确认颜色正确 ②确认无毛刺	<input checked="" type="checkbox"/>	装配
41	4379	H1100638A01		1	黑平	①确认颜色正确 ②确认无毛刺	<input checked="" type="checkbox"/>	装配
42	4697	X33607A01		1	独立发泡 スポンジ N.B.R	①确认颜色正确 ②确认无毛刺	<input checked="" type="checkbox"/>	装配
43	4699	H2602061A01		2	灰皱	①确认颜色正确 ②确认无毛刺	<input checked="" type="checkbox"/>	装配
44	4702	H2601785A03		1	黑平	①确认颜色正确 ②确认无毛刺	<input checked="" type="checkbox"/>	装配

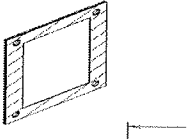
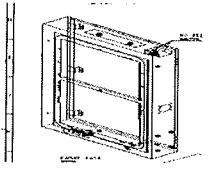
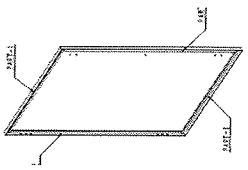
45	4703	H2601754A04		1	黑平	①确认颜色正确 ②确认无毛刺	<input checked="" type="checkbox"/>	装配
46	4704	5382482		1	黑皱	确认颜色正确 确认无毛刺 确认无变形 过丝确认	<input checked="" type="checkbox"/> <input checked="" type="checkbox"/> <input checked="" type="checkbox"/> <input checked="" type="checkbox"/>	装配
47	4705	5382484		1	黑皱	确认颜色正确 确认无毛刺 确认无变形 过丝确认	<input checked="" type="checkbox"/> <input checked="" type="checkbox"/> <input checked="" type="checkbox"/> <input checked="" type="checkbox"/>	装配