

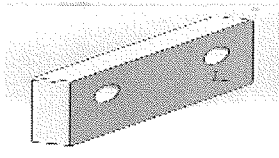

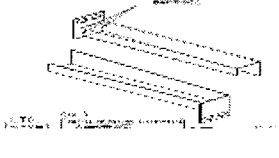

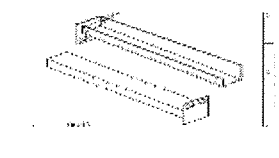

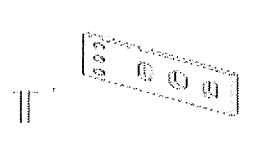

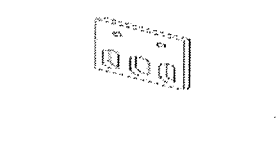
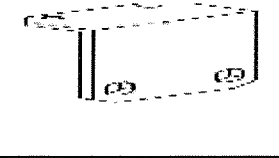
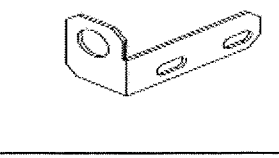
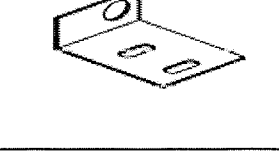
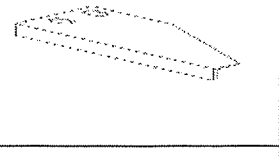

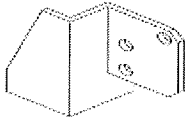
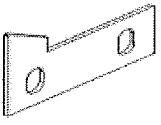
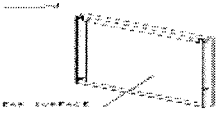





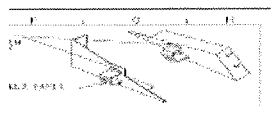
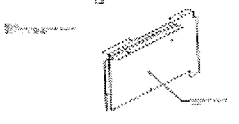

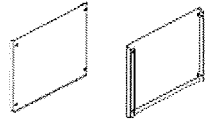
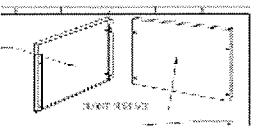
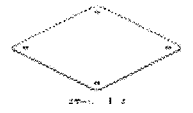
CMXC1230813-800本体

序号	物料号	内部号	简图	数量	颜色		备注
1	B4000690A01	2		1	黑平/黑色 /9005HS50	①确认颜色正确 ②确认无毛刺	<input checked="" type="checkbox"/> <input checked="" type="checkbox"/>
2	H0103669B01	2		1	黑平/黑/9005HS50	①确认颜色正确 ②确认无毛刺	<input checked="" type="checkbox"/> <input checked="" type="checkbox"/>
3	H0103670B01	2		1	黑平/黑/9005HS50	①确认颜色正确 ②确认无毛刺	<input checked="" type="checkbox"/> <input checked="" type="checkbox"/>
4	H1301747A01	2		1	白皱/カルサイトホ ワイト (凹凸) /9NT06835HL	确认颜色正确 确认无变形 过丝无毛刺 确认无毛刺	<input checked="" type="checkbox"/> <input checked="" type="checkbox"/> <input checked="" type="checkbox"/> <input checked="" type="checkbox"/>
5	H1301748A01	2		1	白皱/カルサイトホ ワイト (凹凸) /9NT06835HL	确认颜色正确 确认无变形 过丝无毛刺 确认无毛刺	<input checked="" type="checkbox"/> <input checked="" type="checkbox"/> <input checked="" type="checkbox"/> <input checked="" type="checkbox"/>
6	H1502598A02	2		1	黑平/黑色 /9005HS50	确认颜色正确 确认无变形 过丝无毛刺 确认无毛刺	<input checked="" type="checkbox"/> <input checked="" type="checkbox"/> <input checked="" type="checkbox"/> <input checked="" type="checkbox"/>
7	H1502599A02	2		1	黑平/黑色 /9005HS50	①确认颜色正确 ②确认无毛刺	<input checked="" type="checkbox"/> <input checked="" type="checkbox"/>
8	H1502610A02	2		1	黑平/黑色 /9005HS50	①确认颜色正确 ②确认无毛刺	<input checked="" type="checkbox"/> <input checked="" type="checkbox"/>
9	H1502616A02	2		1	黑平/黑色 /9005HS50	①确认颜色正确 ②确认无毛刺	<input checked="" type="checkbox"/> <input checked="" type="checkbox"/>
10	H1502684B01	2		2	黑皱/グラフィト ブラック (凹凸) /0NT00281HL	①确认颜色正确 ②确认无毛刺	<input checked="" type="checkbox"/> <input checked="" type="checkbox"/>

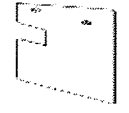
11	H1604732A01	2		1	黒平/黒色 /9005HS50	①確認颜色正确 ②確認无毛刺	<input checked="" type="checkbox"/> <input checked="" type="checkbox"/>
12	H3001439A01	2		1	白皱/カルサイトホ ワイト /9NT06835HL	①確認颜色正确 ②確認无毛刺	<input checked="" type="checkbox"/> <input checked="" type="checkbox"/>
13	H8105042A02	2		1	白皱/カルサイトホ ワイト (凹凸) /9NT06835HL	確認颜色正确 確認无变形 过丝无毛刺 確認无毛刺	<input checked="" type="checkbox"/> <input checked="" type="checkbox"/> <input checked="" type="checkbox"/> <input checked="" type="checkbox"/>
14	H8105044A02	2		1	白皱/カルサイトホ ワイト (凹凸) /9NT06835HL	確認颜色正确 確認无变形 过丝无毛刺 確認无毛刺	<input checked="" type="checkbox"/> <input checked="" type="checkbox"/> <input checked="" type="checkbox"/> <input checked="" type="checkbox"/>
15	H8105046A02	2		1	白皱/カルサイトホ ワイト (凹凸) /9NT06835HL	確認颜色正确 確認无变形 过丝无毛刺 確認无毛刺	<input checked="" type="checkbox"/> <input checked="" type="checkbox"/> <input checked="" type="checkbox"/> <input checked="" type="checkbox"/>
16	H8105072B03	2		1	白皱/カルサイトホ ワイト (凹凸) /9NT06835HL	確認颜色正确 確認无变形 过丝无毛刺 確認无毛刺	<input checked="" type="checkbox"/> <input checked="" type="checkbox"/> <input checked="" type="checkbox"/> <input checked="" type="checkbox"/>
17	H8105075A03	2		1	白皱/カルサイトホ ワイト (凹凸) /9NT06835HL	確認颜色正确 確認无变形 过丝无毛刺 確認无毛刺	<input checked="" type="checkbox"/> <input checked="" type="checkbox"/> <input checked="" type="checkbox"/> <input checked="" type="checkbox"/>
18	H8105095B01	2		1	白皱/カルサイトホ ワイト (凹凸) /9NT06835HL	確認颜色正确 確認无变形 过丝无毛刺 確認无毛刺	<input checked="" type="checkbox"/> <input checked="" type="checkbox"/> <input checked="" type="checkbox"/> <input checked="" type="checkbox"/>
19	H8105096B01	2		1	白皱/カルサイトホ ワイト (凹凸) /9NT06835HL	確認颜色正确 確認无变形 过丝无毛刺 確認无毛刺	<input checked="" type="checkbox"/> <input checked="" type="checkbox"/> <input checked="" type="checkbox"/> <input checked="" type="checkbox"/>
20	H8105122A01	2		1	白皱/カルサイトホ ワイト /9NT06835HL	確認颜色正确 確認无变形 过丝无毛刺 確認无毛刺	<input checked="" type="checkbox"/> <input checked="" type="checkbox"/> <input checked="" type="checkbox"/> <input checked="" type="checkbox"/>
21	H8105123C01	2		1	白皱/カルサイトホ ワイト /9NT06835HL	確認颜色正确 確認无变形 过丝无毛刺 確認无毛刺	<input checked="" type="checkbox"/> <input checked="" type="checkbox"/> <input checked="" type="checkbox"/> <input checked="" type="checkbox"/>

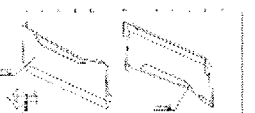
22	H8105125A02	2		1	白皱/カルサイトホワイト /9NT06835HL	①确认颜色正确 ②确认无毛刺	<input checked="" type="checkbox"/> <input checked="" type="checkbox"/>
23	H8105135A01	2		1	白皱/カルサイトホワイト /9NT06835HL	确认颜色正确 确认无变形 过丝无毛刺 确认无毛刺	<input checked="" type="checkbox"/> <input checked="" type="checkbox"/> <input checked="" type="checkbox"/> <input checked="" type="checkbox"/>
24	H8105163A01	2		1	白皱/カルサイトホワイト /9NT06835HL	确认颜色正确 确认无变形 过丝无毛刺 确认无毛刺	<input checked="" type="checkbox"/> <input checked="" type="checkbox"/> <input checked="" type="checkbox"/> <input checked="" type="checkbox"/>
25	H8105170A01	2		1	白皱/カルサイトホワイト /9NT06835HL	①确认颜色正确 ②确认无毛刺	<input checked="" type="checkbox"/> <input checked="" type="checkbox"/>
26	H8105184B01	2		1	白皱/カルサイトホワイト (凹凸) /9NT06835HL	确认颜色正确 确认无变形 过丝无毛刺	<input checked="" type="checkbox"/> <input checked="" type="checkbox"/> <input checked="" type="checkbox"/>
27	H8105195B05	2		1	白皱/カルサイトホワイト /9NT06835HL	确认颜色正确 确认无变形 过丝无毛刺 确认无毛刺	<input checked="" type="checkbox"/> <input checked="" type="checkbox"/> <input checked="" type="checkbox"/> <input checked="" type="checkbox"/>
28	H8105196B02	2		1	白皱/カルサイトホワイト /9NT06835HL	确认颜色正确 确认无变形 过丝无毛刺	<input checked="" type="checkbox"/> <input checked="" type="checkbox"/> <input checked="" type="checkbox"/>
29	H8105264A02	2		1	黒平/黒涂装 /9005HS50	确认颜色正确 确认无变形 过丝无毛刺	<input checked="" type="checkbox"/> <input checked="" type="checkbox"/> <input checked="" type="checkbox"/>
30	H8105533A01	2		1	白皱/カルサイトホワイト (凹凸) /9NT06835HL	①确认颜色正确 ②确认无毛刺	<input checked="" type="checkbox"/> <input checked="" type="checkbox"/>
31	H8106230A02	2		1	黒皱/グラファイトブラック (凹凸) /0NT00281HL	确认颜色正确 确认无变形 过丝无毛刺 确认无毛刺	<input checked="" type="checkbox"/> <input checked="" type="checkbox"/> <input checked="" type="checkbox"/> <input checked="" type="checkbox"/>
32	H3001418A01	2		2	白皱/カルサイトホワイト /9NT06835HL	确认颜色正确 确认无变形 过丝无毛刺	<input checked="" type="checkbox"/> <input checked="" type="checkbox"/> <input checked="" type="checkbox"/>

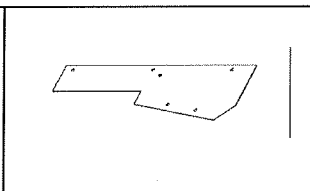
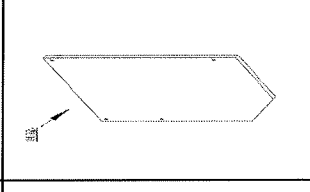
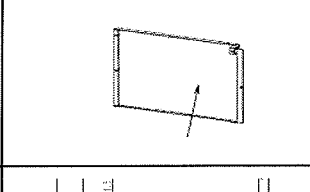
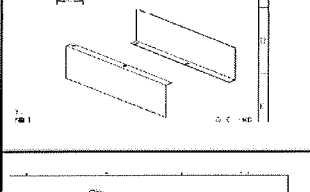
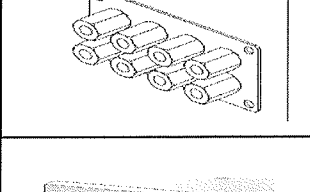
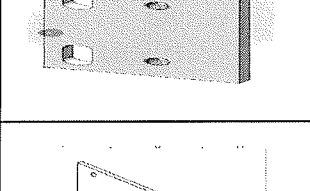
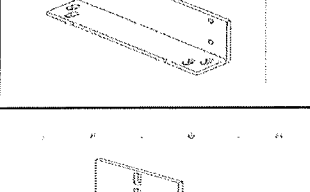
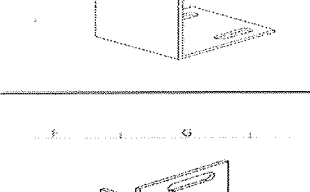
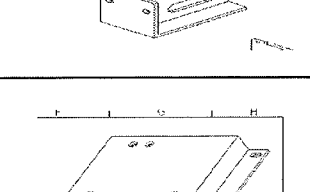
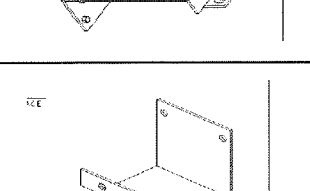
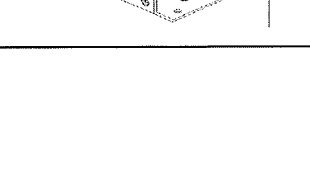
33	H8105484A01	2		1	白皱/カルサイトホワイト /9NT06835HL	确认颜色正确 确认无变形 过丝无毛刺 确认无毛刺	<input checked="" type="checkbox"/> <input checked="" type="checkbox"/> <input checked="" type="checkbox"/> <input checked="" type="checkbox"/>	
34	H8105512A01	2		1	白皱/カルサイトホワイト (凹凸) /9NT06835HL	①确认颜色正确 ②确认无毛刺	<input checked="" type="checkbox"/> <input checked="" type="checkbox"/>	
35	H8105513A01	2		1	白皱/カルサイトホワイト (凹凸) /9NT06835HL	确认颜色正确 确认无变形 过丝无毛刺 确认无毛刺	<input checked="" type="checkbox"/> <input checked="" type="checkbox"/> <input checked="" type="checkbox"/> <input checked="" type="checkbox"/>	
36	H8105245A01	2		1	白皱/カルサイトホワイト (凹凸) /9NT06835HL	确认颜色正确 确认无变形 过丝无毛刺	<input checked="" type="checkbox"/> <input checked="" type="checkbox"/> <input checked="" type="checkbox"/>	
37	H3001565A01	2		1	白皱/カルサイトホワイト (凹凸) /9NT06835HL	确认颜色正确 确认无变形 过丝无毛刺 确认无毛刺	<input checked="" type="checkbox"/> <input checked="" type="checkbox"/> <input checked="" type="checkbox"/> <input checked="" type="checkbox"/>	
38	B4101298A01	2		2	黑平	确认颜色正确 确认无变形 过丝无毛刺	<input checked="" type="checkbox"/> <input checked="" type="checkbox"/> <input checked="" type="checkbox"/>	
39	B6802831A01	2		1	黑平/黑/9005HS50	确认颜色正确 确认无变形 过丝无毛刺 确认无毛刺	<input checked="" type="checkbox"/> <input checked="" type="checkbox"/> <input checked="" type="checkbox"/> <input checked="" type="checkbox"/>	
40	H1301716A02	2		1	黑平/黑色 /9005HS50	确认颜色正确 确认无变形 过丝无毛刺 确认无毛刺	<input checked="" type="checkbox"/> <input checked="" type="checkbox"/> <input checked="" type="checkbox"/> <input checked="" type="checkbox"/>	
41	H1301717A02	2		1	白皱/カルサイトホワイト (凹凸) /9NT06835HL	确认颜色正确 确认无变形 过丝无毛刺 确认无毛刺	<input checked="" type="checkbox"/> <input checked="" type="checkbox"/> <input checked="" type="checkbox"/> <input checked="" type="checkbox"/>	
42	H1604879A01	2		1	黑平/黑涂装 /9005HS50	确认颜色正确 确认无变形 过丝无毛刺 确认无毛刺	<input checked="" type="checkbox"/> <input checked="" type="checkbox"/> <input checked="" type="checkbox"/> <input checked="" type="checkbox"/>	
43	H1604880A03	2			白皱/カルサイトホワイト /9NT06835HL	确认颜色正确 确认无变形 过丝无毛刺 确认无毛刺	<input checked="" type="checkbox"/> <input checked="" type="checkbox"/> <input checked="" type="checkbox"/> <input checked="" type="checkbox"/>	

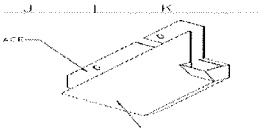
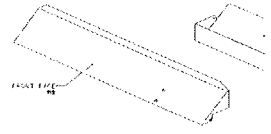
44	H8106330A01	2		1	白皱/カルサイトホ ワイト (凹凸) /9NT06835HL	确认颜色正确 确认无变形 过丝无毛刺 确认无毛刺	<input checked="" type="checkbox"/> <input checked="" type="checkbox"/> <input checked="" type="checkbox"/> <input checked="" type="checkbox"/>
45	5304887	2		1	白皱/カルサイトホ ワイト /9NT06835HL	确认颜色正确 确认无变形 过丝无毛刺 确认无毛刺	<input checked="" type="checkbox"/> <input checked="" type="checkbox"/> <input checked="" type="checkbox"/>