

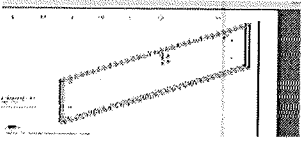
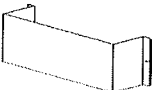
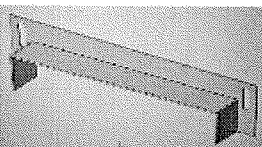
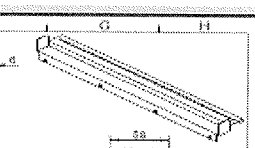
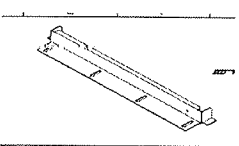
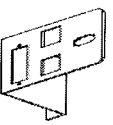
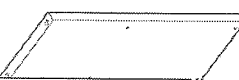
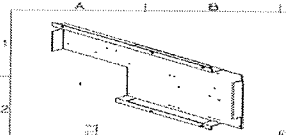
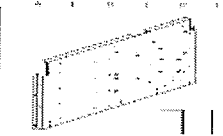
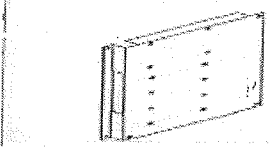

NHC5524电柜0601第二十批

序号	物料号	内部号	简图	数量	颜色	检查内容	备注
1	H2601638	3722		1	灰皱	确认颜色正确 确认无毛刺 确认无变形 过丝确认	<input checked="" type="checkbox"/> <input checked="" type="checkbox"/> <input checked="" type="checkbox"/> <input checked="" type="checkbox"/>
	H2601638B01(2/4)	3722	无图贴在3722柜体上	1	灰皱	①确认颜色正确 ②确认无毛刺	<input checked="" type="checkbox"/> <input checked="" type="checkbox"/>
	H2601638B01(3/4)	3722	无图贴在3722柜体上	1	灰皱	①确认颜色正确 ②确认无毛刺	<input checked="" type="checkbox"/> <input checked="" type="checkbox"/>
	H2601638B01(4/4)	3722	无图贴在3722柜体上	1	灰皱	①确认颜色正确 ②确认无毛刺	<input checked="" type="checkbox"/> <input checked="" type="checkbox"/>
	H2601853A01	3722	无图贴在3722柜体上	2	灰皱	①确认颜色正确 ②确认无毛刺	<input checked="" type="checkbox"/> <input checked="" type="checkbox"/>
	H2601795A01A	3722	无图贴在3722柜体上	1	灰皱	①确认颜色正确 ②确认无毛刺	<input checked="" type="checkbox"/> <input checked="" type="checkbox"/>
	H2601645A02	3725		1	灰皱	①确认颜色正确 ②确认无毛刺	<input checked="" type="checkbox"/> <input checked="" type="checkbox"/>
2	H2601646A02	3726		2	灰皱	①确认颜色正确 ②确认无毛刺	<input checked="" type="checkbox"/> <input checked="" type="checkbox"/>
3	H2601639A03	3727		1	灰皱	①确认颜色正确 ②确认无毛刺	<input checked="" type="checkbox"/> <input checked="" type="checkbox"/>
4	H2B069A01	3728		2	三价镀锌	①确认颜色正确 ②确认无毛刺	<input checked="" type="checkbox"/> <input checked="" type="checkbox"/>

5	H2A959A01	3729		1	三价镀锌	①确认颜色正确 ②确认无毛刺	<input checked="" type="checkbox"/> <input checked="" type="checkbox"/>
6	H2601782A01	3730		2	三价镀锌	①确认颜色正确 ②确认无毛刺	<input checked="" type="checkbox"/> <input checked="" type="checkbox"/>
7	H2601169A02	3731		1	三价镀锌	①确认颜色正确 ②确认无毛刺	<input checked="" type="checkbox"/> <input checked="" type="checkbox"/>
8	H2601182A02	3732		1	三价镀锌	①确认颜色正确 ②确认无毛刺	<input checked="" type="checkbox"/> <input checked="" type="checkbox"/>
9	H2601247A01	3733		1	三价镀锌	①确认颜色正确 ②确认无毛刺	<input checked="" type="checkbox"/> <input checked="" type="checkbox"/>
10	H2602535A01	3734		1	三价镀锌	①确认颜色正确 ②确认无毛刺	<input checked="" type="checkbox"/> <input checked="" type="checkbox"/>
11	H2601788B02	3742		1	三价电镀	①确认颜色正确 ②确认无毛刺	<input checked="" type="checkbox"/> <input checked="" type="checkbox"/>
12	H2601633A06	3743		1	三价电镀	确认颜色正确 确认无毛刺 确认无变形 过丝确认	<input checked="" type="checkbox"/> <input checked="" type="checkbox"/> <input checked="" type="checkbox"/> <input checked="" type="checkbox"/>
13	H2601635A04	3744		1	三价电镀	确认颜色正确 确认无毛刺 确认无变形 过丝确认	<input checked="" type="checkbox"/> <input checked="" type="checkbox"/> <input checked="" type="checkbox"/> <input checked="" type="checkbox"/>
14	H2601636A09	3745		1	三价电镀	确认颜色正确 确认无毛刺 确认无变形 过丝确认	<input checked="" type="checkbox"/> <input checked="" type="checkbox"/> <input checked="" type="checkbox"/> <input checked="" type="checkbox"/>
15	H2601789A01	3746		1	三价电镀	①确认颜色正确 ②确认无毛刺	<input checked="" type="checkbox"/> <input checked="" type="checkbox"/>

16	H2601844B01	3747		1	三阶电镀	①确认颜色正确 ②确认无毛刺	<input checked="" type="checkbox"/>
17	H2601637A01	3748		1	三阶电镀	①确认颜色正确 ②确认无毛刺	<input checked="" type="checkbox"/>
18	H2601654A02	3749		1	灰皱	①确认颜色正确 ②确认无毛刺	<input checked="" type="checkbox"/>
19	H2601791A01	3750		1	灰皱	①确认颜色正确 ②确认无毛刺	<input checked="" type="checkbox"/>
20	H2601787A04	3751		1	三阶电镀	确认颜色正确 确认无毛刺 确认无变形 过丝确认	<input checked="" type="checkbox"/>
21	H2601794A01	3752		1	三阶电镀	确认颜色正确 确认无毛刺 确认无变形 过丝确认	<input checked="" type="checkbox"/>
22	5180360	3753		1	灰皱	确认颜色正确 确认无毛刺 确认无变形 过丝确认	<input checked="" type="checkbox"/>
23	H2601666A02	3754		1	灰皱	①确认颜色正确 ②确认无毛刺	<input checked="" type="checkbox"/>
24	H2601668A03	3755		1	灰皱	确认颜色正确 确认无毛刺 确认无变形 过丝确认	<input checked="" type="checkbox"/>
25	5180359	3756		1	灰皱	确认颜色正确 确认无毛刺 确认无变形 过丝确认	<input checked="" type="checkbox"/>
26	H2601792A02	3757		1	灰皱	确认颜色正确 确认无毛刺 确认无变形 过丝确认	<input checked="" type="checkbox"/>

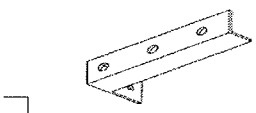
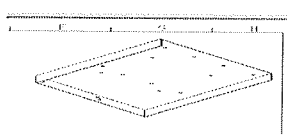
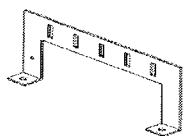
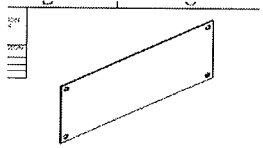
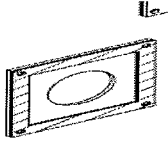
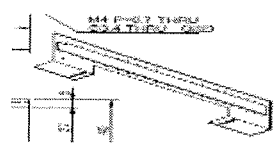
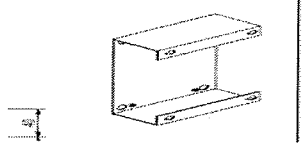
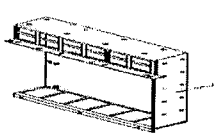
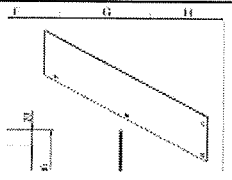
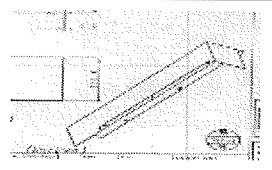
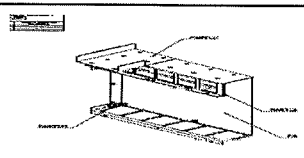
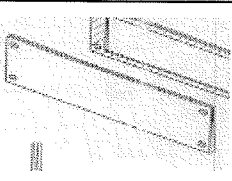
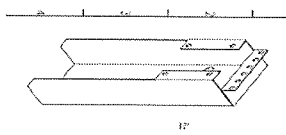
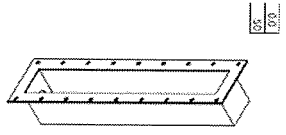
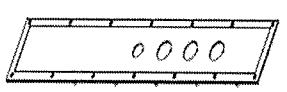
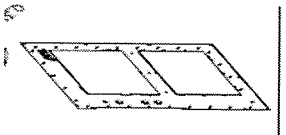
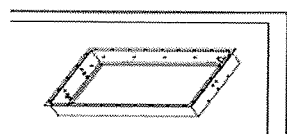
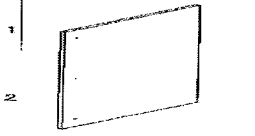
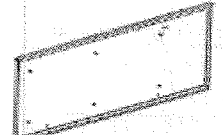
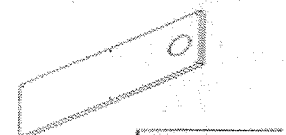
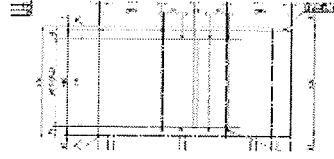
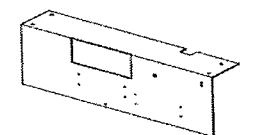
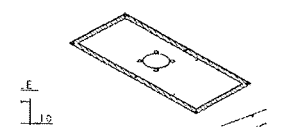
27	H2601955A01	3758		1	灰皱	确认颜色正确 确认无毛刺 确认无变形 过丝确认	<input checked="" type="checkbox"/> <input checked="" type="checkbox"/> <input checked="" type="checkbox"/> <input checked="" type="checkbox"/>
28	H2601776A02	3759		1	灰皱	确认颜色正确 确认无毛刺 确认无变形 过丝确认	<input checked="" type="checkbox"/> <input checked="" type="checkbox"/> <input checked="" type="checkbox"/> <input checked="" type="checkbox"/>
29	H2601777A06	3760		1	黑平	确认颜色正确 确认无毛刺 确认无变形 过丝确认	<input checked="" type="checkbox"/> <input checked="" type="checkbox"/> <input checked="" type="checkbox"/> <input checked="" type="checkbox"/>
30	H2601900A02	3763		1	黑皱	确认颜色正确 确认无毛刺 确认无变形 过丝确认	<input checked="" type="checkbox"/> <input checked="" type="checkbox"/> <input checked="" type="checkbox"/> <input checked="" type="checkbox"/>
31	H6500355A02	3764		1	黑皱	确认颜色正确 确认无毛刺 确认无变形 过丝确认	<input checked="" type="checkbox"/> <input checked="" type="checkbox"/> <input checked="" type="checkbox"/> <input checked="" type="checkbox"/>
32	H6500356A01	3765		1	黑皱	①确认颜色正确 ②确认无毛刺	<input checked="" type="checkbox"/> <input checked="" type="checkbox"/>
33	H2601648A04	3768		1	黑皱	确认颜色正确 确认无毛刺 确认无变形 过丝确认	<input checked="" type="checkbox"/> <input checked="" type="checkbox"/> <input checked="" type="checkbox"/> <input checked="" type="checkbox"/>
34	H2601649A03	3769		1	黑皱	①确认颜色正确 ②确认无毛刺	<input checked="" type="checkbox"/> <input checked="" type="checkbox"/>
35	H2601297A01	3735		1	三价镀锌	确认颜色正确 确认无毛刺 确认无变形 过丝确认	<input checked="" type="checkbox"/> <input checked="" type="checkbox"/> <input checked="" type="checkbox"/> <input checked="" type="checkbox"/>
36	H2602015A03	3739			三价镀锌	确认颜色正确 确认无毛刺 确认无变形 过丝确认	<input checked="" type="checkbox"/> <input checked="" type="checkbox"/> <input checked="" type="checkbox"/> <input checked="" type="checkbox"/>
37	H2602017A01	3740			灰皱	确认颜色正确 确认无毛刺 确认无变形 过丝确认	<input checked="" type="checkbox"/> <input checked="" type="checkbox"/> <input checked="" type="checkbox"/> <input checked="" type="checkbox"/>

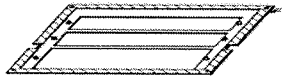
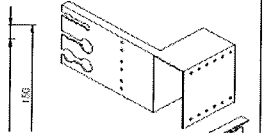
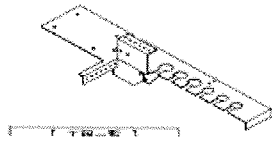
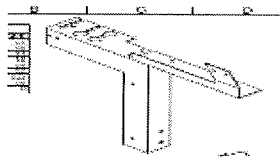
38	H2601690A02	3736		1	三价镀锌	确认颜色正确 确认无毛刺 确认无变形 过丝确认	<input checked="" type="checkbox"/> <input checked="" type="checkbox"/> <input checked="" type="checkbox"/> <input checked="" type="checkbox"/>
39	H2601656A02	3737		1	灰皱	确认颜色正确 确认无毛刺 确认无变形 过丝确认	<input checked="" type="checkbox"/> <input checked="" type="checkbox"/> <input checked="" type="checkbox"/> <input checked="" type="checkbox"/>
40	H2601657A03	3741		1	灰皱	确认颜色正确 确认无毛刺 确认无变形 过丝确认	<input checked="" type="checkbox"/> <input checked="" type="checkbox"/> <input checked="" type="checkbox"/> <input checked="" type="checkbox"/>
41	H1402451A04	3738		1	黑平 (黑平)	确认颜色正确 确认无毛刺 确认无变形 过丝确认	<input checked="" type="checkbox"/> <input checked="" type="checkbox"/> <input checked="" type="checkbox"/> <input checked="" type="checkbox"/>

