

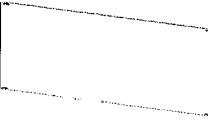

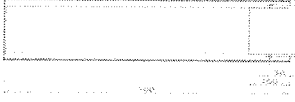

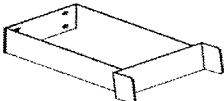

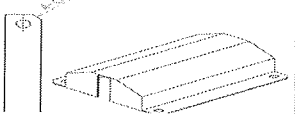



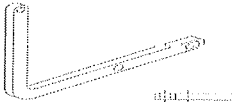



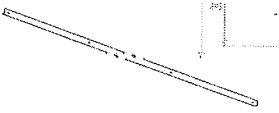
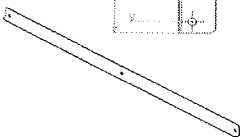
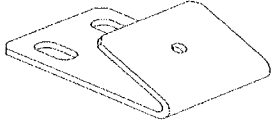

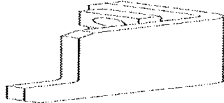
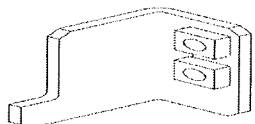

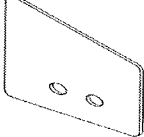

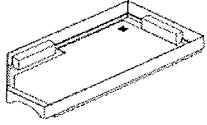

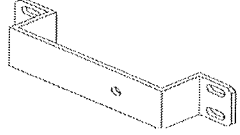
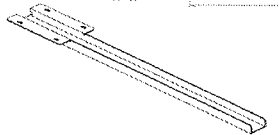
LPP50240603纳期

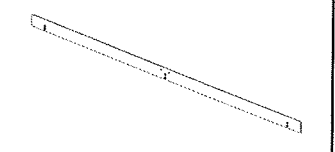
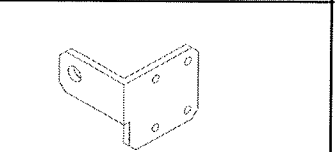
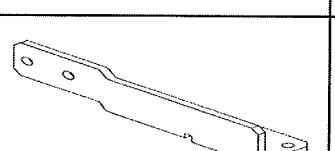
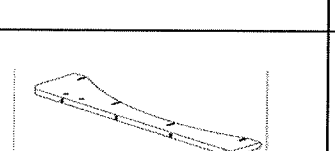
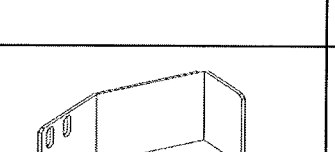
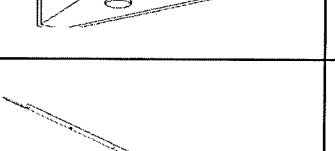
序号	内部号	内部号	简图	数量	颜色	检查内容		
1	3	5145092		1	透明	确认切面平整无毛刺 确认无划伤	<input checked="" type="checkbox"/> <input checked="" type="checkbox"/>	SPP
2	3	5145093		5	透明	确认切面平整无毛刺 确认无划伤	<input checked="" type="checkbox"/> <input checked="" type="checkbox"/>	SPP
3	3	5144685		24	白平	确认颜色正确 确认挂钩点处理 确认无毛刺	<input checked="" type="checkbox"/> <input checked="" type="checkbox"/> <input checked="" type="checkbox"/>	ALW
4	3	5144687		2	黑染め	确认黑染外观 确认无毛刺	<input checked="" type="checkbox"/> <input checked="" type="checkbox"/>	ALW
5	3	5144832		2	白平	确认颜色正确 确认挂钩点处理 确认无毛刺	<input checked="" type="checkbox"/> <input checked="" type="checkbox"/> <input checked="" type="checkbox"/>	ALW
6	3	5144833		4	白平	确认颜色正确 确认挂钩点处理 确认无毛刺	<input checked="" type="checkbox"/> <input checked="" type="checkbox"/> <input checked="" type="checkbox"/>	ALW
7	3	5144809		2	黄色	确认颜色正确 确认挂钩点处理 确认无毛刺	<input checked="" type="checkbox"/> <input checked="" type="checkbox"/> <input checked="" type="checkbox"/>	ALW
8	3	5144699		2	白平	确认颜色正确 确认无毛刺 过丝确认	<input checked="" type="checkbox"/> <input checked="" type="checkbox"/> <input checked="" type="checkbox"/>	ALW
9	3	5144820		4	白平	确认颜色正确 确认挂钩点处理 确认无毛刺	<input checked="" type="checkbox"/> <input checked="" type="checkbox"/> <input checked="" type="checkbox"/>	ALW
10	3	5144769		2	白皱	确认颜色正确 确认无毛刺 过丝确认	<input checked="" type="checkbox"/> <input checked="" type="checkbox"/> <input checked="" type="checkbox"/>	ALW

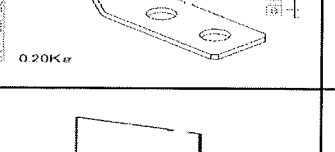
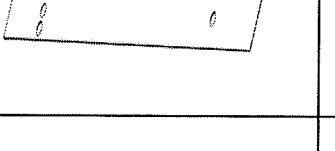
11	3	5144042		2	黄色	确认颜色正确 确认无变形 确认无毛刺	<input checked="" type="checkbox"/> <input checked="" type="checkbox"/> <input checked="" type="checkbox"/>	ALR
12	3	5144047		1	黄色	确认颜色正确 确认无变形 确认无毛刺	<input checked="" type="checkbox"/> <input checked="" type="checkbox"/> <input checked="" type="checkbox"/>	AXL
13	3	5201102		2	白平	确认切面平整无毛刺 确认无划伤	<input checked="" type="checkbox"/> <input checked="" type="checkbox"/>	ALW
14	3	5201143		2	白平	确认切面平整无毛刺 确认无划伤	<input checked="" type="checkbox"/> <input checked="" type="checkbox"/>	ALW
15	3	5201099		2	黒染め	确认切面平整无毛刺 确认无划伤	<input checked="" type="checkbox"/> <input checked="" type="checkbox"/>	ALW
17	3	5201103		2	白平	确认切面平整无毛刺 确认无划伤	<input checked="" type="checkbox"/> <input checked="" type="checkbox"/>	ALW
18	3	5201105		2	白平	确认切面平整无毛刺 确认无划伤	<input checked="" type="checkbox"/> <input checked="" type="checkbox"/>	ALW
22	3	5201152		4	白平	确认切面平整无毛刺 确认无划伤	<input checked="" type="checkbox"/> <input checked="" type="checkbox"/>	ALW
23	3	5201137		2	白皱	确认切面平整无毛刺 确认无划伤	<input checked="" type="checkbox"/> <input checked="" type="checkbox"/>	ALW
24	3	5201138		4	黒平	确认切面平整无毛刺 确认无划伤	<input checked="" type="checkbox"/> <input checked="" type="checkbox"/>	ALW
25	3	5201139		4	黒平	确认切面平整无毛刺 确认无划伤	<input checked="" type="checkbox"/> <input checked="" type="checkbox"/>	ALW

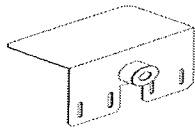
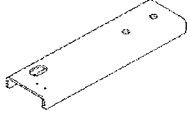
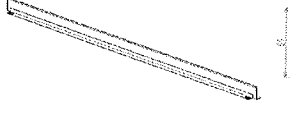
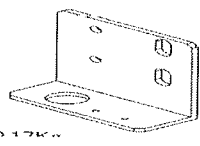

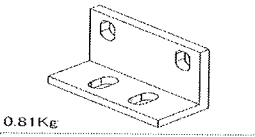

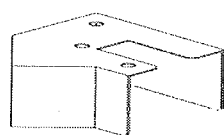
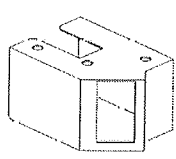
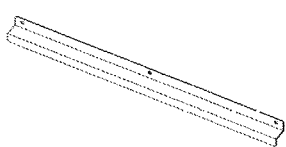
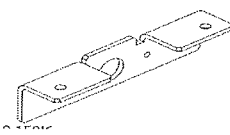

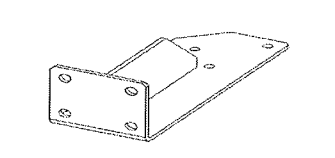
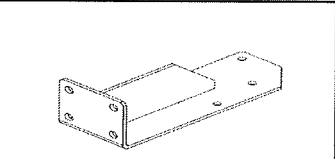
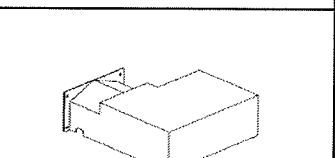
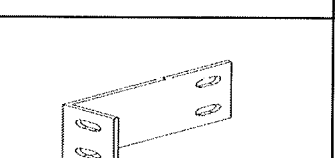
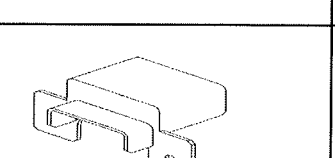
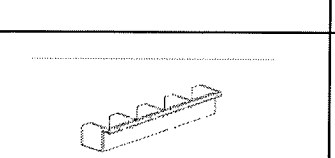
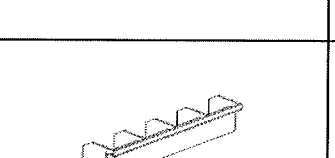
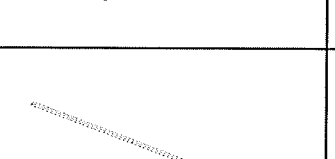
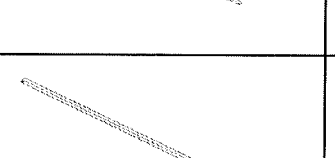
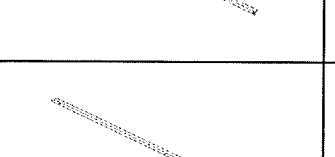
26	3	5201127		2	白平	确认切面平整无毛刺 确认无划伤	<input checked="" type="checkbox"/> <input checked="" type="checkbox"/>	ALW
27	3	5201128		2	白平	确认切面平整无毛刺 确认无划伤	<input checked="" type="checkbox"/> <input checked="" type="checkbox"/>	ALW
28	3	5201129		2	黒染め	确认切面平整无毛刺 确认无划伤	<input checked="" type="checkbox"/> <input checked="" type="checkbox"/>	ALW
29	3	5201130		2	黒染め	确认切面平整无毛刺 确认无划伤	<input checked="" type="checkbox"/> <input checked="" type="checkbox"/>	ALW
30	3	5201124		8	黄色	确认切面平整无毛刺 确认无划伤	<input checked="" type="checkbox"/> <input checked="" type="checkbox"/>	ALW
31	3	5201140		2	白平	确认切面平整无毛刺 确认无划伤	<input checked="" type="checkbox"/> <input checked="" type="checkbox"/>	ALW
32	3	5201101		2	白平	确认切面平整无毛刺 确认无划伤	<input checked="" type="checkbox"/> <input checked="" type="checkbox"/>	ALW
33	3	5201154		2	白皱	确认切面平整无毛刺 确认无划伤	<input checked="" type="checkbox"/> <input checked="" type="checkbox"/>	ALW
35	3	5201114		2	白平	确认切面平整无毛刺 确认无划伤	<input checked="" type="checkbox"/> <input checked="" type="checkbox"/>	ALW
36	3	5201116		2	白平	确认切面平整无毛刺 确认无划伤	<input checked="" type="checkbox"/> <input checked="" type="checkbox"/>	ALW
37	3	5201117		2	白平	确认切面平整无毛刺 确认无划伤	<input checked="" type="checkbox"/> <input checked="" type="checkbox"/>	ALW

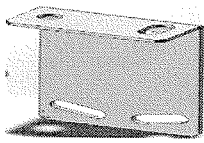
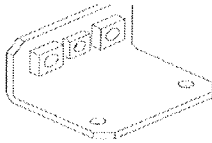
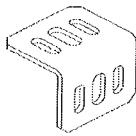
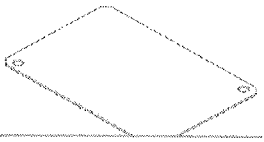
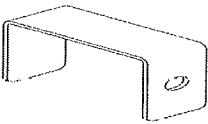
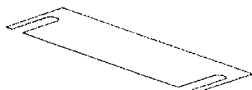
38	3	5201118		2	白皱	确认切面平整无毛刺 确认无划伤	<input checked="" type="checkbox"/> <input checked="" type="checkbox"/>	ALW
44	3	5201149		2	白平	确认切面平整无毛刺 确认无划伤	<input checked="" type="checkbox"/> <input checked="" type="checkbox"/>	ALW
45	3	5201144		2	白平	确认切面平整无毛刺 确认无划伤	<input checked="" type="checkbox"/> <input checked="" type="checkbox"/>	ALW
46	3	5201147		2	白平	确认切面平整无毛刺 确认无划伤	<input checked="" type="checkbox"/> <input checked="" type="checkbox"/>	ALW
47	3	5201115		2	白平	确认切面平整无毛刺 确认无划伤	<input checked="" type="checkbox"/> <input checked="" type="checkbox"/>	ALW
48	3	5201123		2	黄色	确认切面平整无毛刺 确认无划伤	<input checked="" type="checkbox"/> <input checked="" type="checkbox"/>	ALW
50	3	5201126		2	黑平	确认切面平整无毛刺 确认无划伤	<input checked="" type="checkbox"/> <input checked="" type="checkbox"/>	ALW
51	3	5201131		2	黄色	确认切面平整无毛刺 确认无划伤	<input checked="" type="checkbox"/> <input checked="" type="checkbox"/>	ALW
56	3	5201134		2	黑皱	确认颜色正确 确认无变形 确认无毛刺	<input checked="" type="checkbox"/> <input checked="" type="checkbox"/> <input checked="" type="checkbox"/>	ALW
58	3	5201136		2	黑皱	确认颜色正确 确认无变形 确认无毛刺	<input checked="" type="checkbox"/> <input checked="" type="checkbox"/> <input checked="" type="checkbox"/>	ALW
59	3	5201113		2	白平	确认颜色正确 确认无变形 确认无毛刺	<input checked="" type="checkbox"/> <input checked="" type="checkbox"/> <input checked="" type="checkbox"/>	ALW

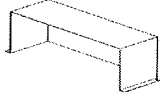
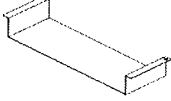

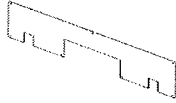
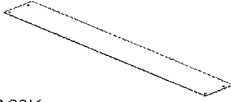
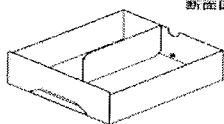
60	3	5199439		2	灰平	确认颜色正确 确认无变形 确认无毛刺	<input checked="" type="checkbox"/> <input checked="" type="checkbox"/> <input checked="" type="checkbox"/>	ALR
61	3	5199441		1	灰平	确认颜色正确 确认无变形 确认无毛刺	<input checked="" type="checkbox"/> <input checked="" type="checkbox"/> <input checked="" type="checkbox"/>	ALR
63	3	5199438		4	灰平	确认颜色正确 确认无变形 确认无毛刺	<input checked="" type="checkbox"/> <input checked="" type="checkbox"/> <input checked="" type="checkbox"/>	ALR
64	3	5200348		1	灰平	确认颜色正确 确认无变形 确认无毛刺	<input checked="" type="checkbox"/> <input checked="" type="checkbox"/> <input checked="" type="checkbox"/>	AXL
65	3	5200353		4	灰平	确认颜色正确 确认无变形 确认无毛刺	<input checked="" type="checkbox"/> <input checked="" type="checkbox"/> <input checked="" type="checkbox"/>	AXL
66	3	5200350		3	黄色	确认颜色正确 确认无变形 确认无毛刺	<input checked="" type="checkbox"/> <input checked="" type="checkbox"/> <input checked="" type="checkbox"/>	AXL
67	3	5200501		1	灰平	确认颜色正确 确认无变形 确认无毛刺	<input checked="" type="checkbox"/> <input checked="" type="checkbox"/> <input checked="" type="checkbox"/>	AZL
68	3	5200508		1	灰平	确认颜色正确 确认无变形 确认无毛刺	<input checked="" type="checkbox"/> <input checked="" type="checkbox"/> <input checked="" type="checkbox"/>	AZL
69	3	5200509		1	灰平	确认颜色正确 确认无变形 确认无毛刺	<input checked="" type="checkbox"/> <input checked="" type="checkbox"/> <input checked="" type="checkbox"/>	AZL
70	3	5200513		1	灰平	确认颜色正确 确认无变形 确认无毛刺	<input checked="" type="checkbox"/> <input checked="" type="checkbox"/> <input checked="" type="checkbox"/>	AZL
71	3	5200496		1	灰平	确认颜色正确 确认无变形 确认无毛刺	<input checked="" type="checkbox"/> <input checked="" type="checkbox"/> <input checked="" type="checkbox"/>	AZL

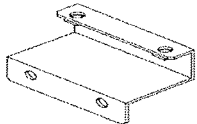
72	3	5200500		1	灰平	确认颜色正确 确认无变形 确认无毛刺	<input type="checkbox"/> <input checked="" type="checkbox"/> <input checked="" type="checkbox"/>	AZL
73	3	5200502		1	灰平	确认颜色正确 确认无变形 确认无毛刺	<input checked="" type="checkbox"/> <input checked="" type="checkbox"/> <input checked="" type="checkbox"/>	AZL
74	3	5200503		1	灰平	确认颜色正确 确认无变形 确认无毛刺	<input checked="" type="checkbox"/> <input checked="" type="checkbox"/> <input checked="" type="checkbox"/>	AZL
75	3	5200506		1	灰平	确认颜色正确 确认无变形 确认无毛刺	<input checked="" type="checkbox"/> <input checked="" type="checkbox"/> <input checked="" type="checkbox"/>	AZL
76	3	5200507		2	黄色	确认颜色正确 确认无变形 确认无毛刺	<input checked="" type="checkbox"/> <input checked="" type="checkbox"/> <input checked="" type="checkbox"/>	AZL
77	3	5200511		1	灰平	确认颜色正确 确认无变形 确认无毛刺	<input checked="" type="checkbox"/> <input checked="" type="checkbox"/> <input checked="" type="checkbox"/>	AZL
78	3	5365119		1	灰平	确认颜色正确 确认无变形 确认无毛刺	<input checked="" type="checkbox"/> <input checked="" type="checkbox"/> <input checked="" type="checkbox"/>	AZL
79	3	5365118		1	灰平	确认颜色正确 确认无变形 确认无毛刺	<input checked="" type="checkbox"/> <input checked="" type="checkbox"/> <input checked="" type="checkbox"/>	AZL
80	3	5E+06		4	灰平	确认颜色正确 确认无变形 确认无毛刺	<input checked="" type="checkbox"/> <input checked="" type="checkbox"/> <input checked="" type="checkbox"/>	LCF
81	3	5E+06		1	灰平	确认颜色正确 确认无变形 确认无毛刺	<input checked="" type="checkbox"/> <input checked="" type="checkbox"/> <input checked="" type="checkbox"/>	LCF
82	3	5E+06		1	灰平	确认颜色正确 确认无变形 确认无毛刺	<input checked="" type="checkbox"/> <input checked="" type="checkbox"/> <input checked="" type="checkbox"/>	LCF

83	3	5199472		1	(空白)	确认颜色正确 确认无变形 确认无毛刺	<input checked="" type="checkbox"/> <input checked="" type="checkbox"/> <input checked="" type="checkbox"/>	AYL
84	3	5200357		2	灰平	确认颜色正确 确认无变形 确认无毛刺	<input checked="" type="checkbox"/> <input checked="" type="checkbox"/> <input checked="" type="checkbox"/>	AZL
85	3	5144762		2	白皱	确认颜色正确 确认无毛刺 过丝确认	<input checked="" type="checkbox"/> <input checked="" type="checkbox"/> <input checked="" type="checkbox"/>	ALW
86	3	5144763		2	白皱	确认颜色正确 确认挂钩点处理 确认无毛刺	<input checked="" type="checkbox"/> <input checked="" type="checkbox"/> <input checked="" type="checkbox"/>	ALW
87	3	5144767		2	黒染め	确认黒染外观 确认无毛刺	<input checked="" type="checkbox"/> <input checked="" type="checkbox"/>	ALW
88	3	5144768		2	黒染め	确认黒染外观 确认无毛刺	<input checked="" type="checkbox"/> <input checked="" type="checkbox"/>	ALW
89	3	5145109		2	白皱	确认切面平整无毛刺 确认无划伤	<input checked="" type="checkbox"/> <input checked="" type="checkbox"/>	ALW
90	3	5144926		2	灰平	确认颜色正确 确认无毛刺	<input checked="" type="checkbox"/> <input checked="" type="checkbox"/>	ALR
91	3	5144923		2	灰平	确认颜色正确 确认无毛刺	<input checked="" type="checkbox"/> <input checked="" type="checkbox"/>	ALR
93	3	5358375		2	白皱	确认颜色正确 确认无毛刺	<input checked="" type="checkbox"/> <input checked="" type="checkbox"/>	ALW
96	3	5200495		1	不要	确认颜色正确 确认无变形 确认无毛刺	<input checked="" type="checkbox"/> <input checked="" type="checkbox"/> <input checked="" type="checkbox"/>	AZL

99	3	5145098	 2.67K	2	白皱	确认颜色正确 确认颜色正确 确认无变形 确认无毛刺	<input checked="" type="checkbox"/> <input checked="" type="checkbox"/> <input checked="" type="checkbox"/> <input checked="" type="checkbox"/>	LCO
100	3	5144903		1	灰平	确认颜色正确 确认无毛刺	<input checked="" type="checkbox"/> <input type="checkbox"/>	LCA
101	3	5144908		1	灰平	确认颜色正确 确认无毛刺	<input checked="" type="checkbox"/> <input checked="" type="checkbox"/>	LCA
102	3	5144910		9	灰平	确认颜色正确 确认无毛刺 过丝确认	<input checked="" type="checkbox"/> <input checked="" type="checkbox"/> <input checked="" type="checkbox"/>	LCA
104	3	5145097		1	白皱	确认颜色正确 确认无变形 确认无毛刺	<input checked="" type="checkbox"/> <input checked="" type="checkbox"/> <input checked="" type="checkbox"/>	LCO
105	3	5145099	 2.92K	1	白皱	确认颜色正确 确认无变形 确认无毛刺	<input checked="" type="checkbox"/> <input checked="" type="checkbox"/> <input checked="" type="checkbox"/>	LCO
106	3	5145100	 2.00K	1	白皱	确认颜色正确 确认无变形 确认无毛刺	<input checked="" type="checkbox"/> <input checked="" type="checkbox"/> <input checked="" type="checkbox"/>	LCO
107	3	5145101	 新视图 A	1	白皱	确认颜色正确 确认无变形 确认无毛刺	<input checked="" type="checkbox"/> <input checked="" type="checkbox"/> <input checked="" type="checkbox"/>	LCO
108	3	5145106		2	白皱	确认颜色正确 确认无变形 确认无毛刺	<input checked="" type="checkbox"/> <input checked="" type="checkbox"/> <input type="checkbox"/>	LCO
109	3	5145103		1	白皱	确认颜色正确 确认无变形 确认无毛刺	<input checked="" type="checkbox"/> <input checked="" type="checkbox"/> <input type="checkbox"/>	LCO
110	3	5145104		1	白皱	确认颜色正确 确认无变形 确认无毛刺	<input checked="" type="checkbox"/> <input checked="" type="checkbox"/> <input checked="" type="checkbox"/>	LCO

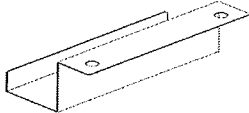

114	3	5200526		5	灰平	确认颜色正确 确认无变形 确认无毛刺	<input checked="" type="checkbox"/> <input checked="" type="checkbox"/> <input checked="" type="checkbox"/>	WSA
115	3	5200548		3	灰平	确认颜色正确 确认无变形 确认无毛刺	<input checked="" type="checkbox"/> <input checked="" type="checkbox"/> <input checked="" type="checkbox"/>	WSA
116	3	5145105		1		确认颜色正确 确认无变形 确认无毛刺	<input checked="" type="checkbox"/> <input checked="" type="checkbox"/> <input checked="" type="checkbox"/>	LCO