

The property and copyright is entitled to: DMG MORI SEIKI CO --Copyright according to 150 16016 consider--		Part Number: 5413519	Doc. No.: H1605379B02	Document type: Part drawing
Rev. No.	Change No.	Date (mm.y)	Changed by	Rev.
001	5209566	21.02.2023	NOBUYUKI MASAIKE	00
Title: CABIN-S - S4CAB (H-t-t-1) Cabin subcomponent		Drawing Number: 5413519		Type: Sheet: 00/3180
DMG MORI		MATERIAL: MASADO FUKUMORI		Scale: 1:2
THIRD ANGLE PROJECTION		Mass: 0.51 kg		SPHC-P

t=1.6
 NO BUIR ALLOWED AT EDGE
 エッジ面はかたむきなし
 CORNER R2~3 WHERE NO INDICATION
 指示なき角R2~3のこと
 PAINT COLOR: CALCITE WHITE (SMOOTH)
 塗装色: カルサイトホワイト(平滑)
 ONLY INDICATED PARTS DIFFER FROM H1605379B02
 H1605379B02 と 部のみ異なる

A B C D E F G H

WARNING: EXPORT CONTROLLED - RESTRICTED - CONFIDENTIAL
 Property of DMG MORI. DISCLOSURE TO FOREIGN PERSON OR ENTITY PROHIBITED. Contact Export Control Dept. for disclosure procedures and approvals. Violations are subject to sanctions incl. termination.

22.05.01 整理文庫

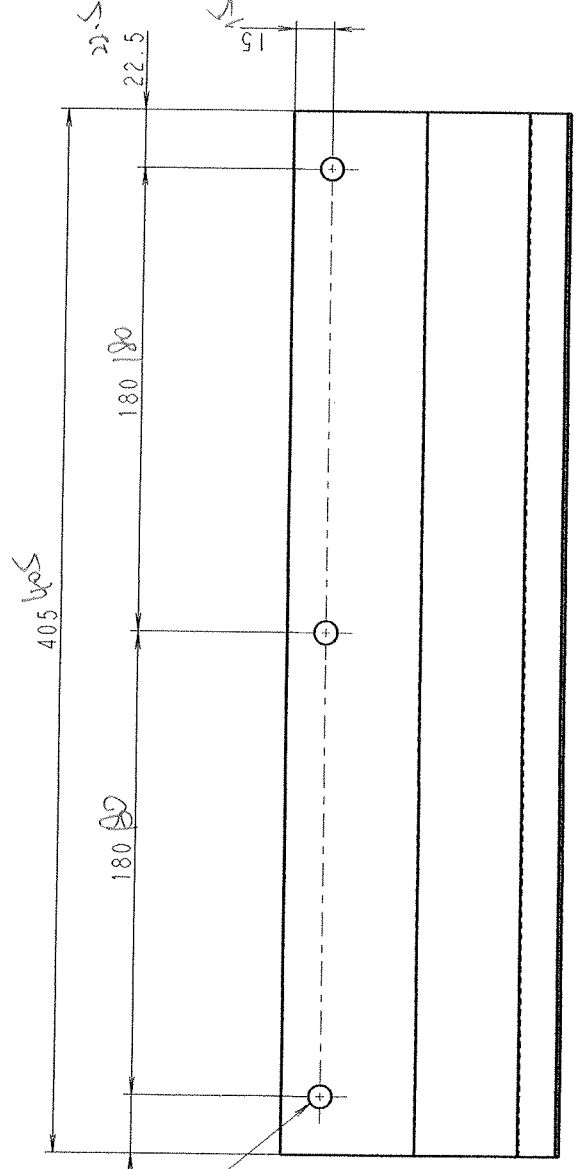
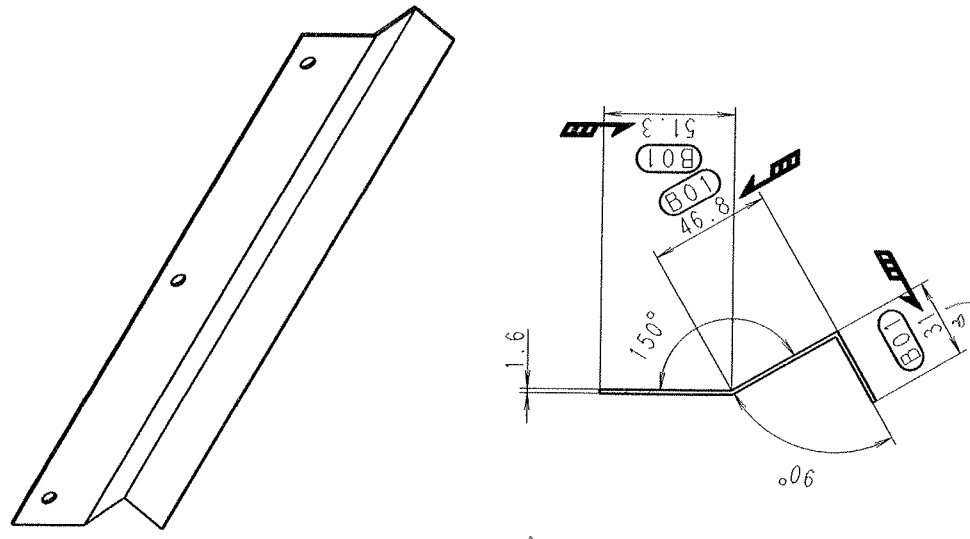

t=1.6

NO BURR ALLOWED AT EDGE

エッジ部はかえりなきこと

CORNER R2.3 WHERE NO INDICATION

指定なき角部R2~3のこと

PAINT COLOR: CALCITE WHITE (SMOOTH)

塗装色: カルサイトホワイト(平滑)

The property and copyright is entitled to: DMG MORI SEIKI CO. --Copyright according to ISO 16016 consider--		Part Number: H160537850	Doc.(c.m.y):	Name: TAKAHITO KAMIYA	Pre: HO	Document type: Part drawing
Rev.	Change No.	Date(c.m.y)	Changed by	Appr.: 27.07.2018	HIRORI NAGAHARA	Mass: 0.65 kg
1				ref.		Format: A3
			THIRD ANGLE PROJECTION		Scale: 1:2	
			Title: COVER		Material: SPHC-P	
			Drawing Number: H1605378		Rev.: B01 02	
			Type: Sheet: 1/1			

NO.	DATE	DESCRIPTION
1	2018.07.27	INITIAL DRAWING
2	2018.07.27	REVISION
3	2018.07.27	REVISION
4	2018.07.27	REVISION
5	2018.07.27	REVISION
6	2018.07.27	REVISION
7	2018.07.27	REVISION
8	2018.07.27	REVISION
9	2018.07.27	REVISION
10	2018.07.27	REVISION

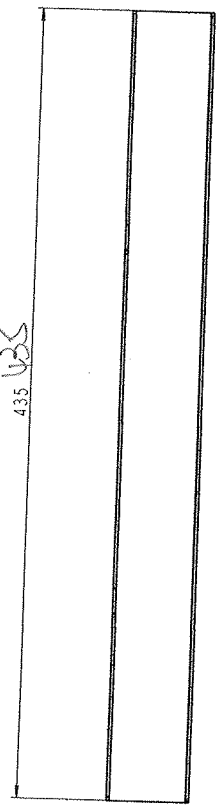
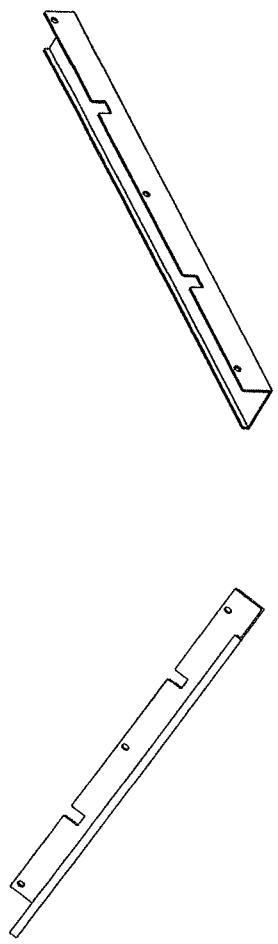

435 425

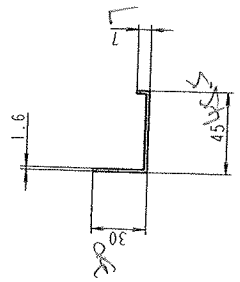
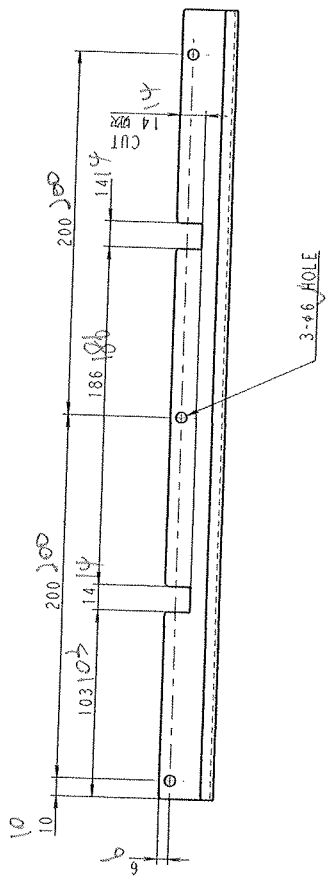

f=1.6

NO BURR ALLOWED AT EDGE
 加工面バリ許容なし

CORNER R<3 WHERE NO INDICATION
 角部R3以下(指示なし)

PAINT COLOR: CALCITE WHITE (SMOOTH)
 塗装色: カルサイトホワイト(滑)

The property and copyright is reserved for DMG MORI (SIA) CO. LTD. All rights reserved. 150° 18186 (copyright)		Part Number	DMG MORI	Docement type:	Part drawing
101	102	103	104	105	106
107	108	109	110	111	112
113	114	115	116	117	118
119	120	121	122	123	124
125	126	127	128	129	130
131	132	133	134	135	136
137	138	139	140	141	142
143	144	145	146	147	148
149	150	151	152	153	154
155	156	157	158	159	160
161	162	163	164	165	166
167	168	169	170	171	172
173	174	175	176	177	178
179	180	181	182	183	184
185	186	187	188	189	190
191	192	193	194	195	196
197	198	199	200	201	202
203	204	205	206	207	208
209	210	211	212	213	214
215	216	217	218	219	220
221	222	223	224	225	226
227	228	229	230	231	232
233	234	235	236	237	238
239	240	241	242	243	244
245	246	247	248	249	250
251	252	253	254	255	256
257	258	259	260	261	262
263	264	265	266	267	268
269	270	271	272	273	274
275	276	277	278	279	280
281	282	283	284	285	286
287	288	289	290	291	292
293	294	295	296	297	298
299	300	301	302	303	304
305	306	307	308	309	310
311	312	313	314	315	316
317	318	319	320	321	322
323	324	325	326	327	328
329	330	331	332	333	334
335	336	337	338	339	340
341	342	343	344	345	346
347	348	349	350	351	352
353	354	355	356	357	358
359	360	361	362	363	364
365	366	367	368	369	370
371	372	373	374	375	376
377	378	379	380	381	382
383	384	385	386	387	388
389	390	391	392	393	394
395	396	397	398	399	400
401	402	403	404	405	406
407	408	409	410	411	412
413	414	415	416	417	418
419	420	421	422	423	424
425	426	427	428	429	430
431	432	433	434	435	436
437	438	439	440	441	442
443	444	445	446	447	448
449	450	451	452	453	454
455	456	457	458	459	460
461	462	463	464	465	466
467	468	469	470	471	472
473	474	475	476	477	478
479	480	481	482	483	484
485	486	487	488	489	490
491	492	493	494	495	496
497	498	499	500	501	502
503	504	505	506	507	508
509	510	511	512	513	514
515	516	517	518	519	520
521	522	523	524	525	526
527	528	529	530	531	532
533	534	535	536	537	538
539	540	541	542	543	544
545	546	547	548	549	550
551	552	553	554	555	556
557	558	559	560	561	562
563	564	565	566	567	568
569	570	571	572	573	574
575	576	577	578	579	580
581	582	583	584	585	586
587	588	589	590	591	592
593	594	595	596	597	598
599	600	601	602	603	604
605	606	607	608	609	610
611	612	613	614	615	616
617	618	619	620	621	622
623	624	625	626	627	628
629	630	631	632	633	634
635	636	637	638	639	640
641	642	643	644	645	646
647	648	649	650	651	652
653	654	655	656	657	658
659	660	661	662	663	664
665	666	667	668	669	670
671	672	673	674	675	676
677	678	679	680	681	682
683	684	685	686	687	688
689	690	691	692	693	694
695	696	697	698	699	700
701	702	703	704	705	706
707	708	709	710	711	712
713	714	715	716	717	718
719	720	721	722	723	724
725	726	727	728	729	730
731	732	733	734	735	736
737	738	739	740	741	742
743	744	745	746	747	748
749	750	751	752	753	754
755	756	757	758	759	760
761	762	763	764	765	766
767	768	769	770	771	772
773	774	775	776	777	778
779	780	781	782	783	784
785	786	787	788	789	790
791	792	793	794	795	796
797	798	799	800	801	802
803	804	805	806	807	808
809	810	811	812	813	814
815	816	817	818	819	820
821	822	823	824	825	826
827	828	829	830	831	832
833	834	835	836	837	838
839	840	841	842	843	844
845	846	847	848	849	850
851	852	853	854	855	856
857	858	859	860	861	862
863	864	865	866	867	868
869	870	871	872	873	874
875	876	877	878	879	880
881	882	883	884	885	886
887	888	889	890	891	892
893	894	895	896	897	898
899	900	901	902	903	904
905	906	907	908	909	910
911	912	913	914	915	916
917	918	919	920	921	922
923	924	925	926	927	928
929	930	931	932	933	934
935	936	937	938	939	940
941	942	943	944	945	946
947	948	949	950	951	952
953	954	955	956	957	958
959	960	961	962	963	964
965	966	967	968	969	970
971	972	973	974	975	976
977	978	979	980	981	982
983	984	985	986	987	988
989	990	991	992	993	994
995	996	997	998	999	1000

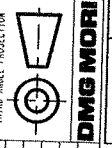

Title: COOLANT COVER_300_500_2000
 Drawing Number: H1605682
 Rev.: A0102
 Type: Part drawing
 Sheet: 1/1

22.05.01 3219