

WARNING: EXPERT CONSULTANTS - REGISTERED - CONFIDENTIAL
 THIS DRAWING IS THE PROPERTY OF THE ENGINEERING CONSULTANTS AND ARCHITECTS (PVT) LTD. AND IS NOT TO BE REPRODUCED OR COPIED IN ANY MANNER WITHOUT THE WRITTEN PERMISSION OF THE ENGINEERING CONSULTANTS AND ARCHITECTS (PVT) LTD.

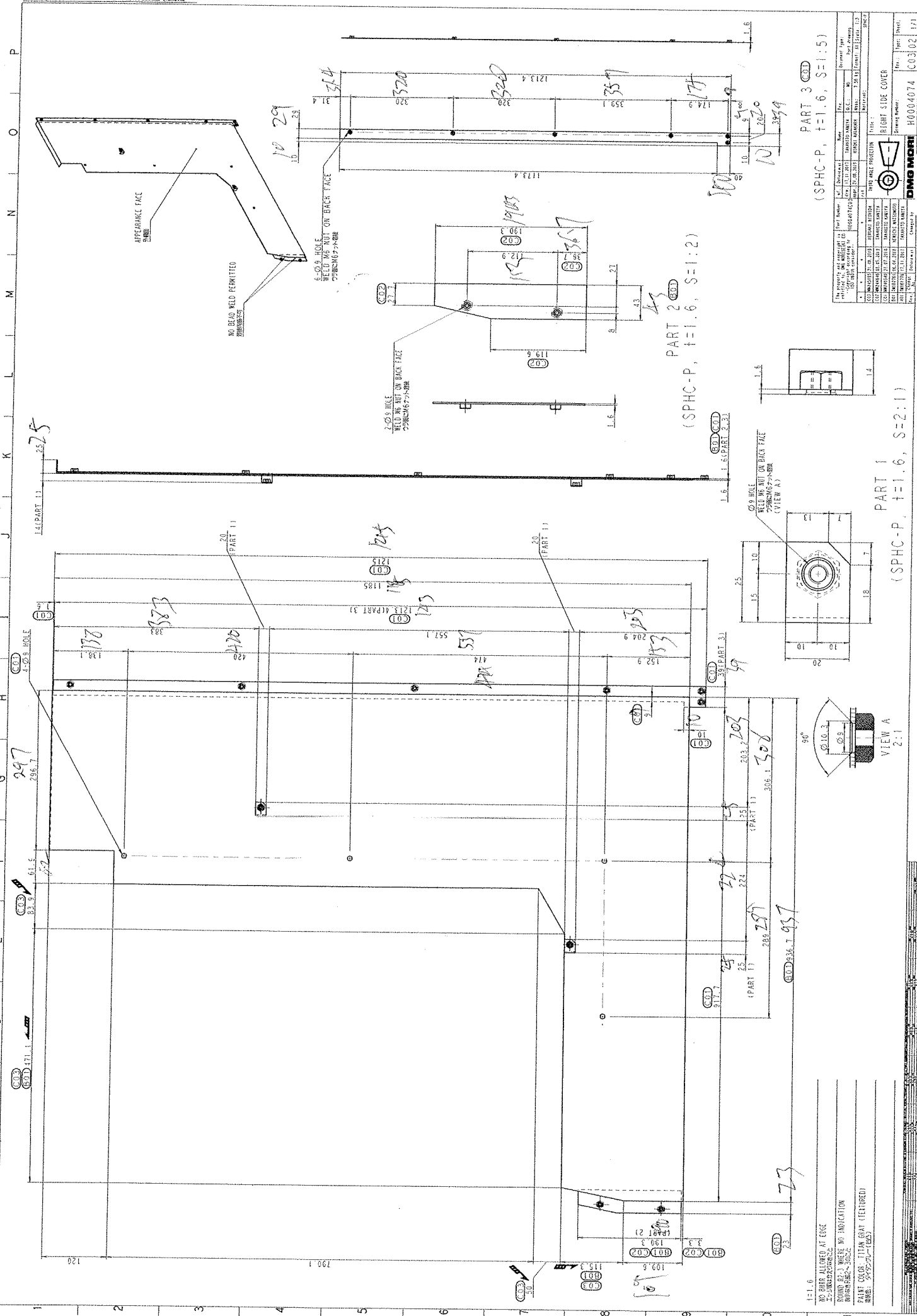

Rev.	Part Number	Issue	Date	By	Checked	Approved
1	00000001	ISSUED FOR MANUFACTURE	27.08.2015	RAJESH K. NARAYAN	S. K. NARAYAN	RAJESH K. NARAYAN
2	00000002	ISSUED FOR MANUFACTURE	27.08.2015	RAJESH K. NARAYAN	S. K. NARAYAN	RAJESH K. NARAYAN
3	00000003	ISSUED FOR MANUFACTURE	27.08.2015	RAJESH K. NARAYAN	S. K. NARAYAN	RAJESH K. NARAYAN

3351 22.04.26

MASSIMO EXPERT CONTROLS - RESTRICTED - CONFIDENTIAL
 This drawing is the property of Massimo Expert Controls. It is not to be reproduced, copied, or used in any way without the written permission of Massimo Expert Controls. All rights reserved.

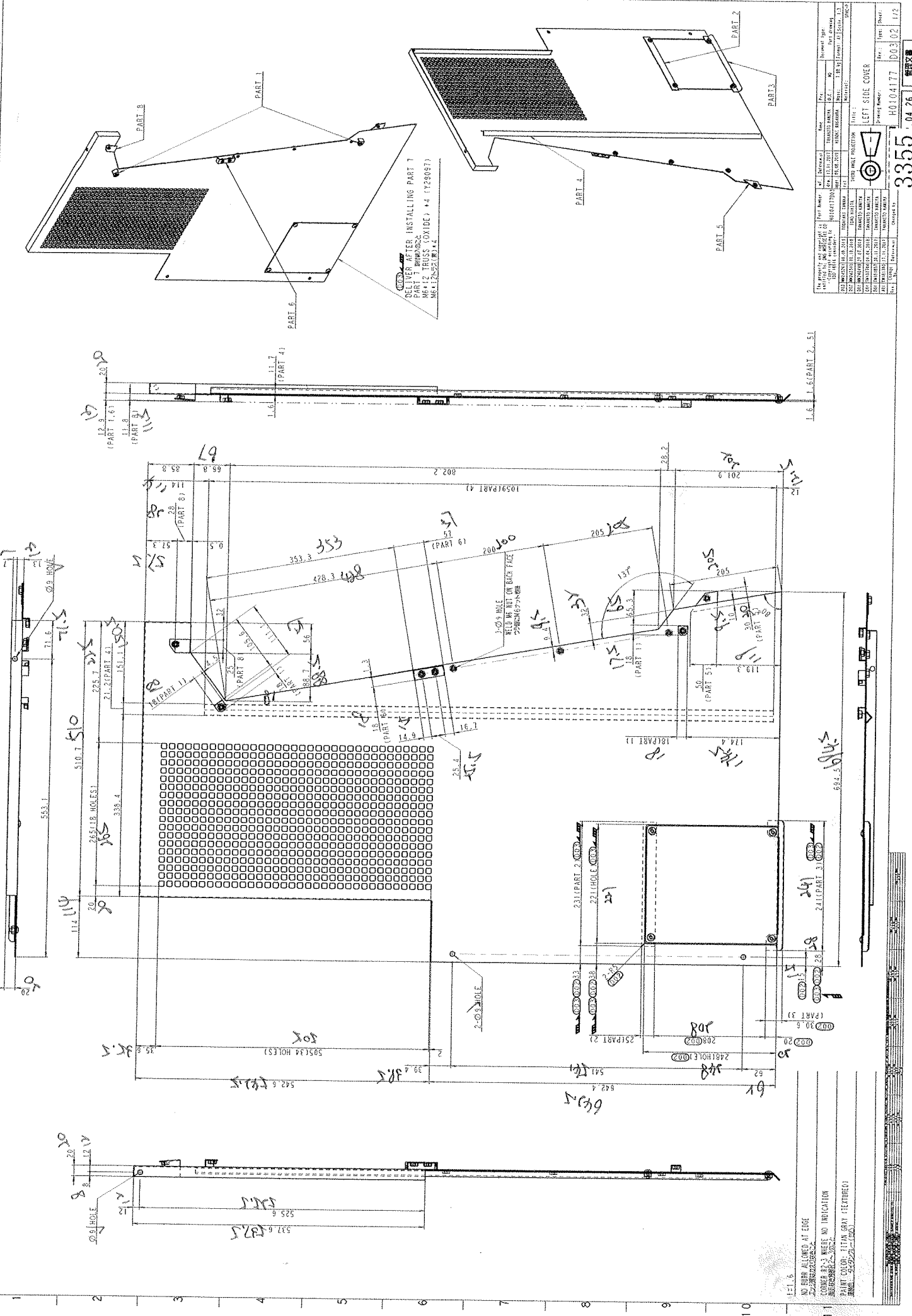

3355

04.26

003.02

112

WARNING: EXPERT CONTRACTOR - RESISTANCE - COMBUSTIBLE
 FORMERLY USED TO BE USED TO PROTECT FROM FIRE PROTECTION. OTHER USES
 CONTRACTOR TO CHECK FOR PROPER INSTALLATION. RESISTANCE TO FIRE AND TO WEAR.

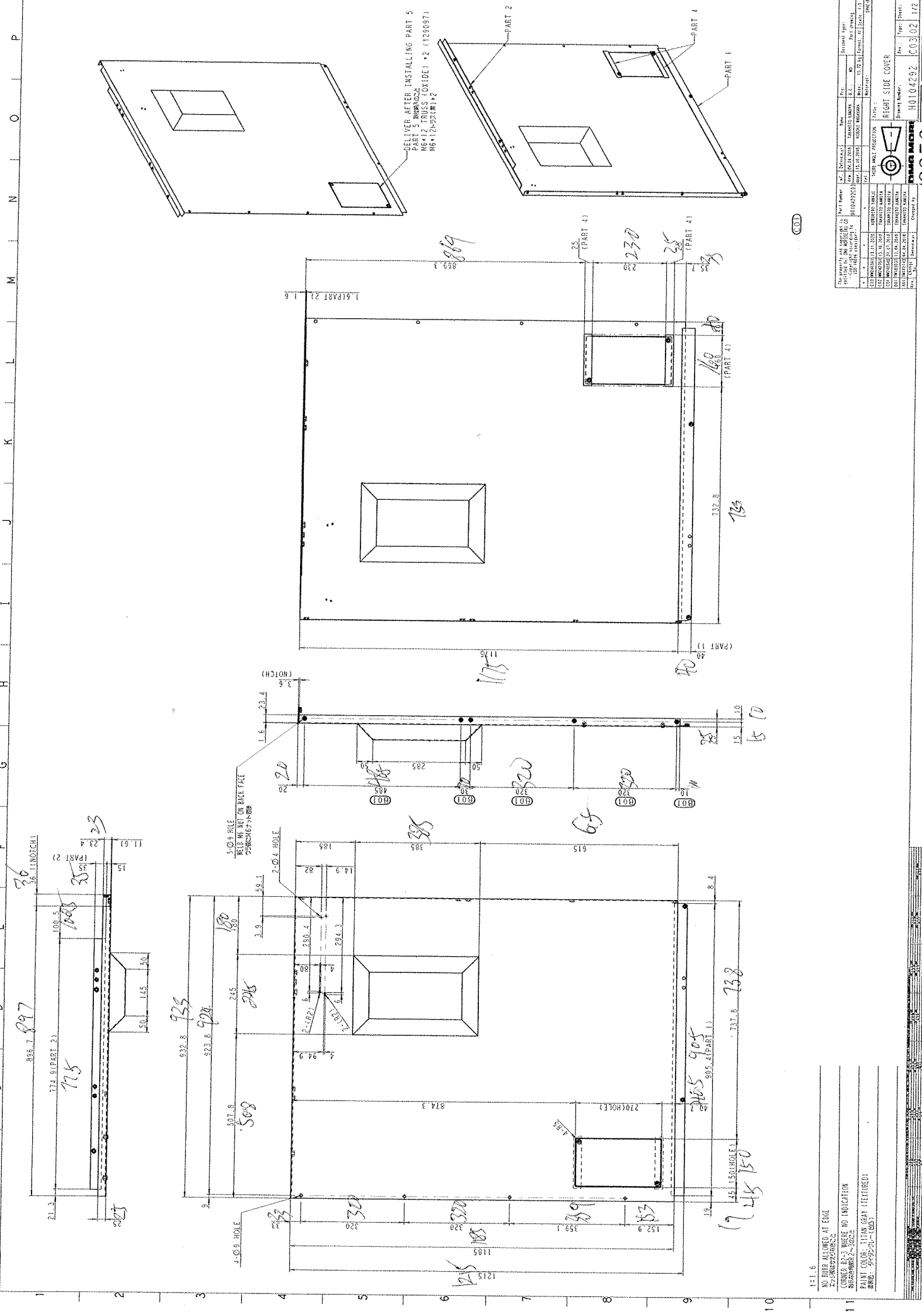

Part Number	Description	Qty	Material	Notes
100	RIGHT SIDE COVER	1	ALUMINUM	
101	TRUSS (CODE) * 2	2	ALUMINUM	
102	M6 * 12 * 20 (R) * 2	2	STEEL	
103	PART 2	1	ALUMINUM	
104	PART 4	1	ALUMINUM	
105	PART 1	1	ALUMINUM	
106	PART 41	1	ALUMINUM	
107	PART 21	1	ALUMINUM	

3356 .04.26 03/02 1/2

RIGHT SIDE COVER

Drawing Number: H0104292

Sheet: 03/02

Scale: 1:1

NO HOLE ALLOWED AT EDGE

CORNER R2-3 WHERE NO INDICATION

BRUSH/PART 2-2022

PAINT COLOR: 111M GRAY (FEATHER)

FINISH: 25-02-21-(005)

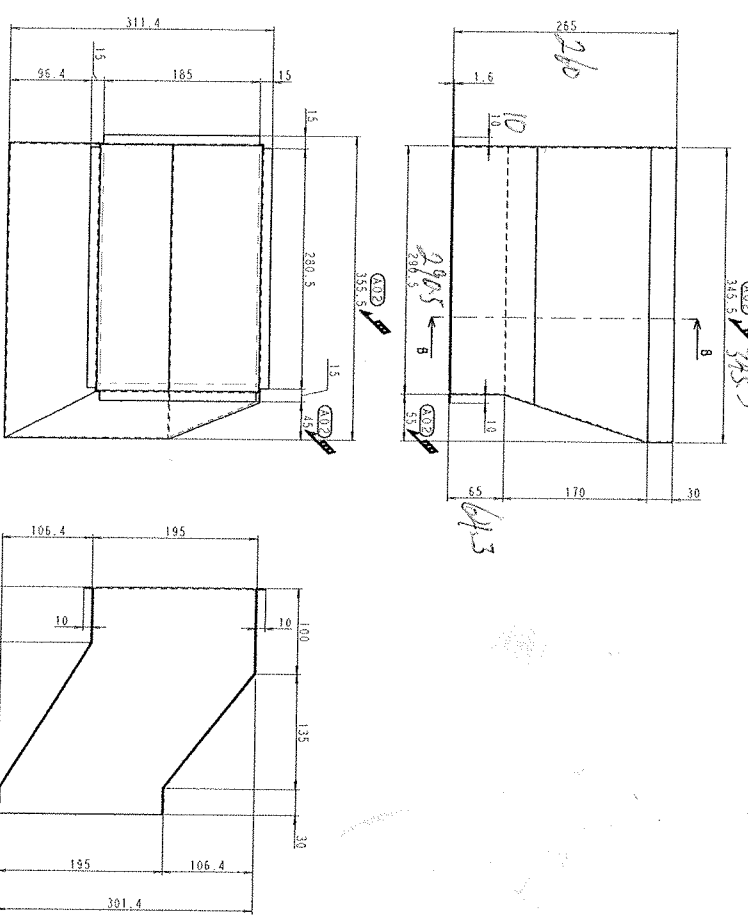
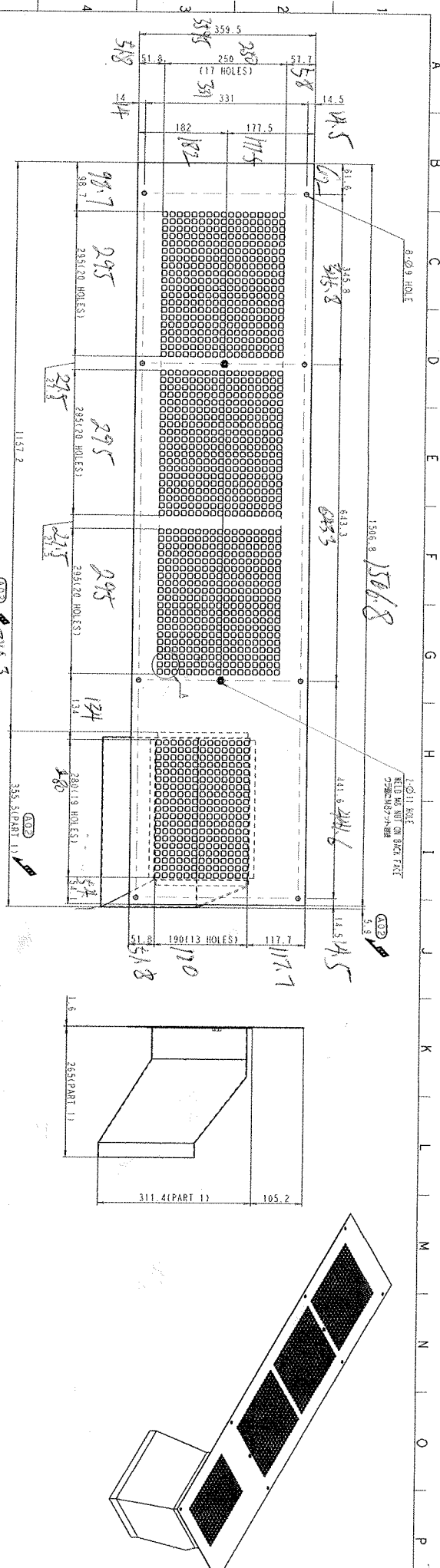

PART 1
 SECTION B-B
 1:1.6, SPHC-P, S=1:3

NO BURN ALLOWED AT THIS
 27-2803242208082
 CORNER B-B3 SHORE NO INDICATION
 PAINT COLOR: LIGHT GRAY (HEX:808080)
 MATERIAL: SPHC-P (1045)

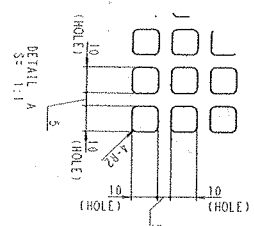
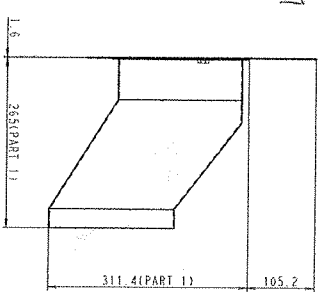

REV	DATE	DESCRIPTION	BY	CHK
1	22.04.26	TOP COVER		

NO. OF PARTS	1	PART NAME	TOP COVER
NO. OF HOLES	513	HOLES	513
NO. OF DIMENSIONS	13	DIMENSIONS	13
NO. OF MATERIALS	1	MATERIALS	1
NO. OF FINISHES	1	FINISHES	1
NO. OF WEIGHTS	1	WEIGHTS	1
NO. OF VOLUMES	1	VOLUMES	1
NO. OF SURFACES	1	SURFACES	1
NO. OF EDGES	1	EDGES	1
NO. OF CORNERS	1	CORNERS	1
NO. OF ROUNDS	1	ROUNDS	1
NO. OF CHAMFERS	1	CHAMFERS	1
NO. OF BEVELS	1	BEVELS	1
NO. OF GROOVES	1	GROOVES	1
NO. OF RECESSES	1	RECESSES	1
NO. OF PROJECTIONS	1	PROJECTIONS	1
NO. OF CUTS	1	CUTS	1
NO. OF DIMENSIONS	13	DIMENSIONS	13
NO. OF MATERIALS	1	MATERIALS	1
NO. OF FINISHES	1	FINISHES	1
NO. OF WEIGHTS	1	WEIGHTS	1
NO. OF VOLUMES	1	VOLUMES	1
NO. OF SURFACES	1	SURFACES	1
NO. OF EDGES	1	EDGES	1
NO. OF CORNERS	1	CORNERS	1
NO. OF ROUNDS	1	ROUNDS	1
NO. OF CHAMFERS	1	CHAMFERS	1
NO. OF BEVELS	1	BEVELS	1
NO. OF GROOVES	1	GROOVES	1
NO. OF RECESSES	1	RECESSES	1
NO. OF PROJECTIONS	1	PROJECTIONS	1
NO. OF CUTS	1	CUTS	1

DMG MORI H0104310 A02102 1/1
 22.04.26 3190

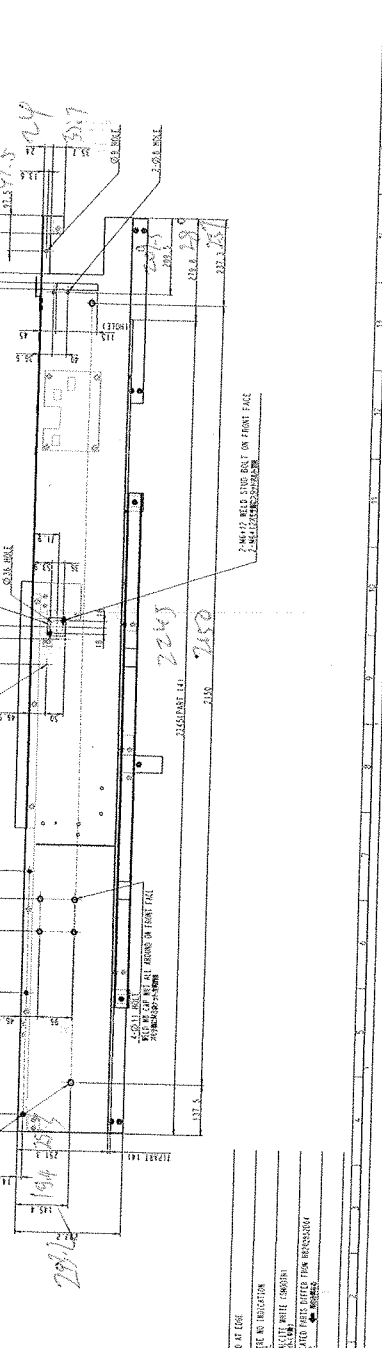
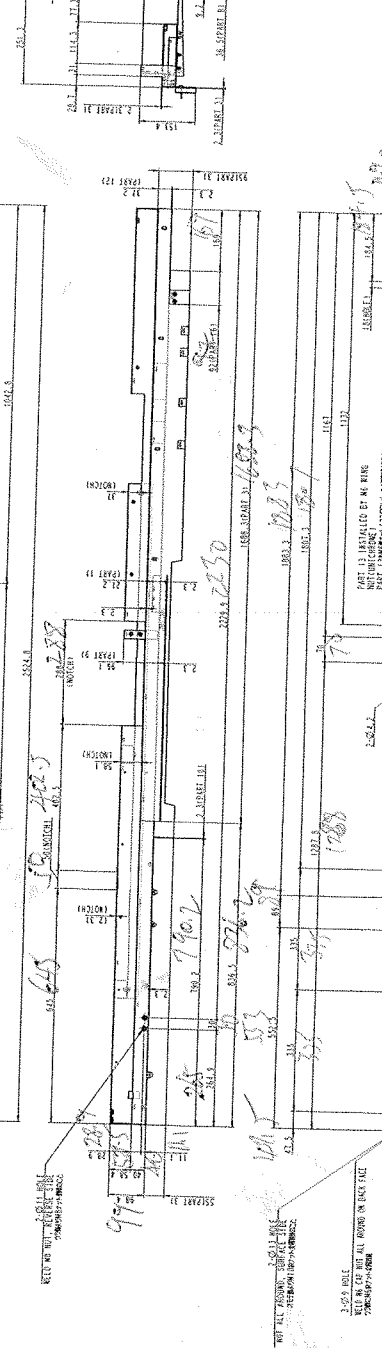
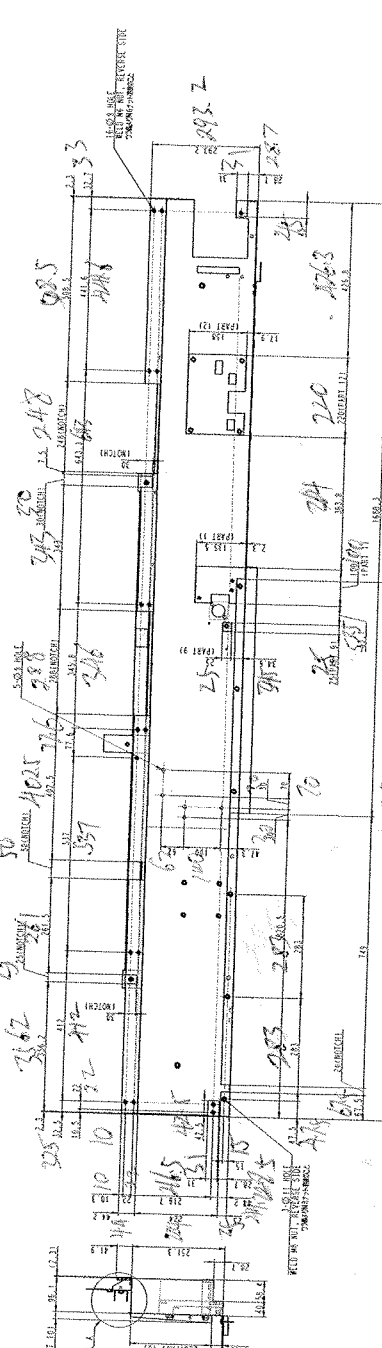
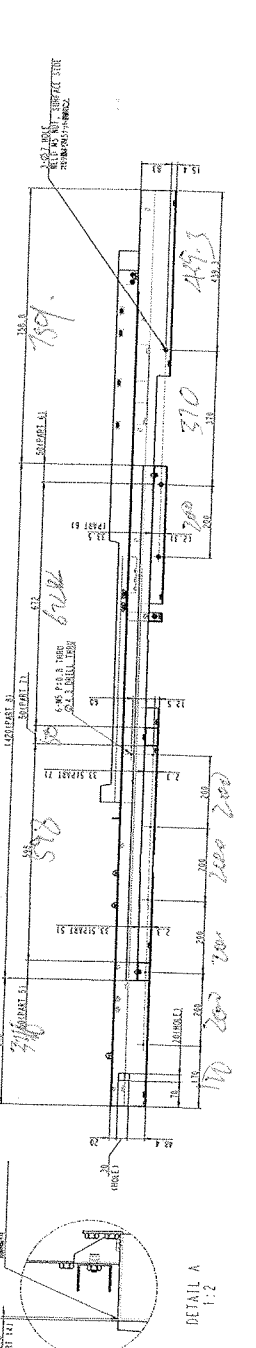
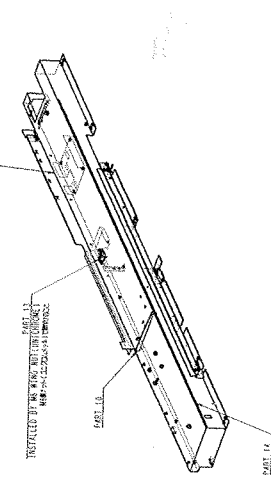
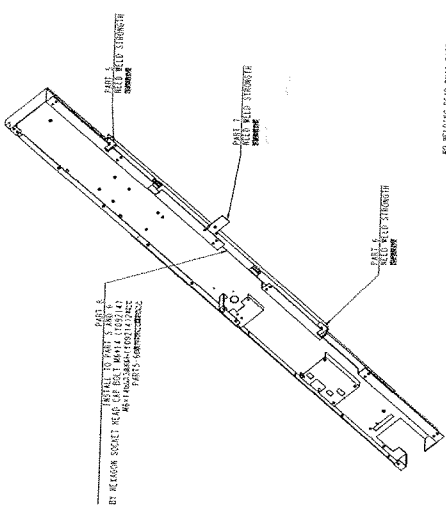
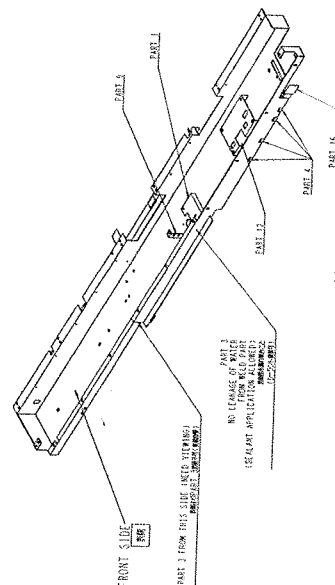

PROJECT: [unreadable]	DATE: [unreadable]	SCALE: [unreadable]
DESIGNED BY: [unreadable]	DESIGNED DATE: [unreadable]	DESIGNED SCALE: [unreadable]
DRAWN BY: [unreadable]	DRAWN DATE: [unreadable]	DRAWN SCALE: [unreadable]
CHECKED BY: [unreadable]	CHECKED DATE: [unreadable]	CHECKED SCALE: [unreadable]
APPROVED BY: [unreadable]	APPROVED DATE: [unreadable]	APPROVED SCALE: [unreadable]
3346		
2023.03.28		