

PART1 (t=1.6, S=1:2, 1PIECE)

PART2 (t=1.6, S=1:1, 1PIECE)

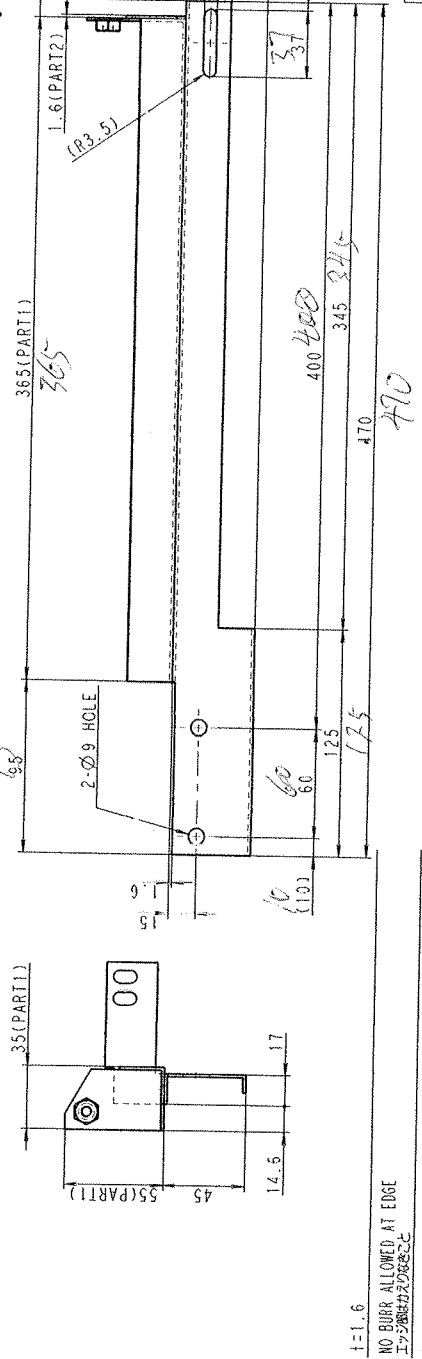
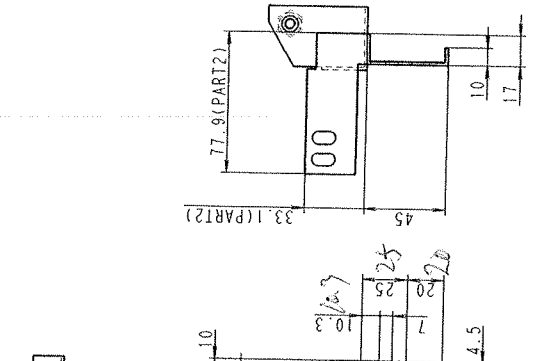

NO BURR ALLOWED AT EDGE  
 エッジバリが認められず

CORNER C1 WHERE NO INDICATION  
 指示が無い箇所C1以下

PAINT COLOR: BLACK  
 塗色: 黒色

Part Number	Name		Description		Decomposition	
02 (A02)	11.11.2017	MORI MASAHIRO	00 C.C.	MD	Part drawing	
03 (A03)	12.11.2017	MORI MASAHIRO	00	MD	Part drawing	
The property and copyright of this drawing are reserved by DMG MORI SEIKI CO., LTD. (INCORPORATED IN JAPAN)		THIRD ANGLE PROJECTION		Material:		SPEC.P
Revision		Change by	Drawn by	Checked by	Title: CHIP COVER	
1					Drawing Number:	H0504732
2					Rev:	02
3					Scale:	1/1

DMG MORI  
 22.04.27 3194

A B C D E F G H

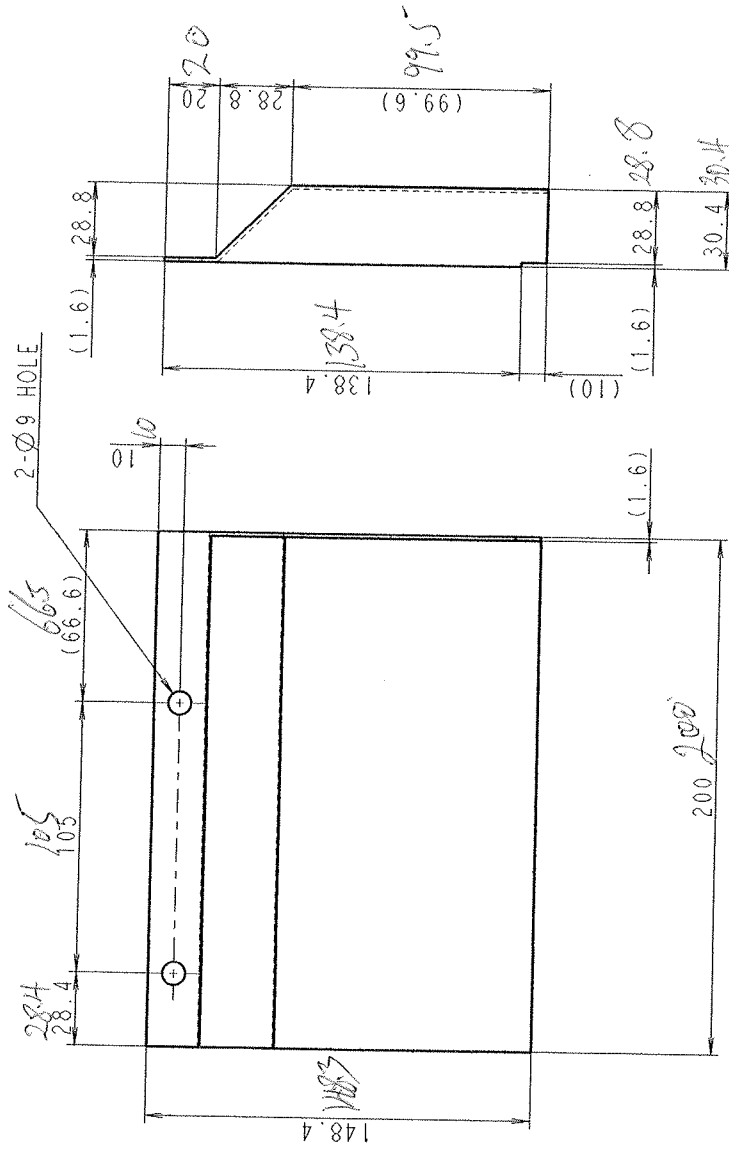
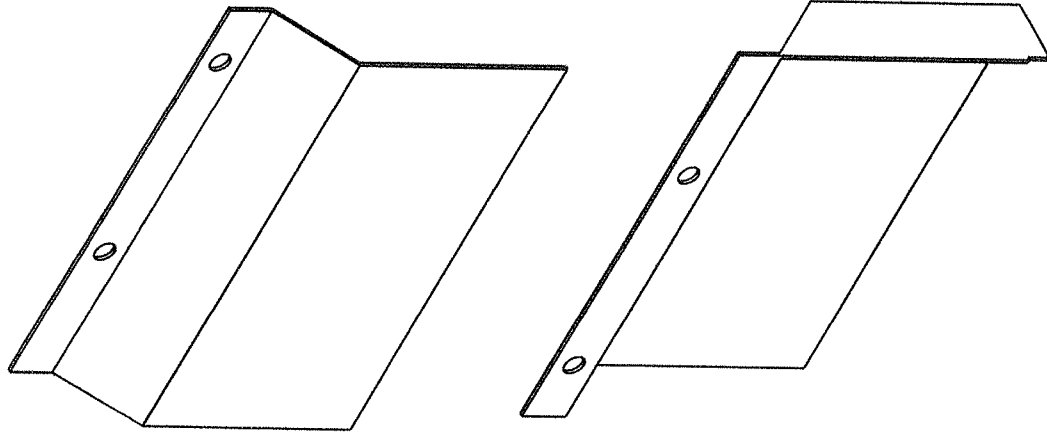

t=1.6

NO BURR ALLOWED AT EDGE  
エッジ部はかえりなきこと

ROUND R2-3 WHERE NO INDICATION  
指定なきRはR2~3のこと

PAINT COLOR: CALCITE WHITE (SMOOTH)  
塗装色: カルサイトホワイト(平滑)

The property and copyright is entitled to: DMG MORI SEIKI CO --Copyright according to ISO 16016 consider--		Part Number: H1605384A01	Defect(m.y): 17.11.2017	Name: TAKAHITO KAMIYA	Pre: MD	Document type: Part drawing
Change No.	1	1	1	1	1	1
Change	1	1	1	1	1	1
Rev.	A01	17.11.2017	TAKAHITO KAMIYA	Title: COVER		
Changed by			Drawing Number: H1605384			
DMG MORI			Rev.: Type: Sheet: A01 02 1/1			
THIRD ANGLE PROJECTION			Material: SPHC-P			

DATE	BY	CHK	APP
17.11.2017	TAKAHITO KAMIYA	HIROKI NAGABARA	HIROKI NAGABARA
17.11.2017	TAKAHITO KAMIYA	HIROKI NAGABARA	HIROKI NAGABARA
17.11.2017	TAKAHITO KAMIYA	HIROKI NAGABARA	HIROKI NAGABARA
17.11.2017	TAKAHITO KAMIYA	HIROKI NAGABARA	HIROKI NAGABARA

管理文書 試作

22.05.01

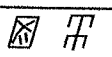

WARNING: EXPORT CONTROLLED - RESTRICTED - CONFIDENTIAL  
Property of DMG MORI. DISCLOSURE TO FOREIGN PERSON OR ENTITY IS PROHIBITED. Contact Export Control Dept. for disclosure procedures and approvals. Violations are subject to sanctions incl. termination.

A B C D E F G H I J K

WARNING: EXPORT CONTROLLED - RESTRICTED - CONFIDENTIAL  
 Property of DMG MORI. Disclosure to foreign persons or entry prohibited. Contact Export Control Dept. for details, procedures and approvals. Violators are subject to sanctions and prosecution.

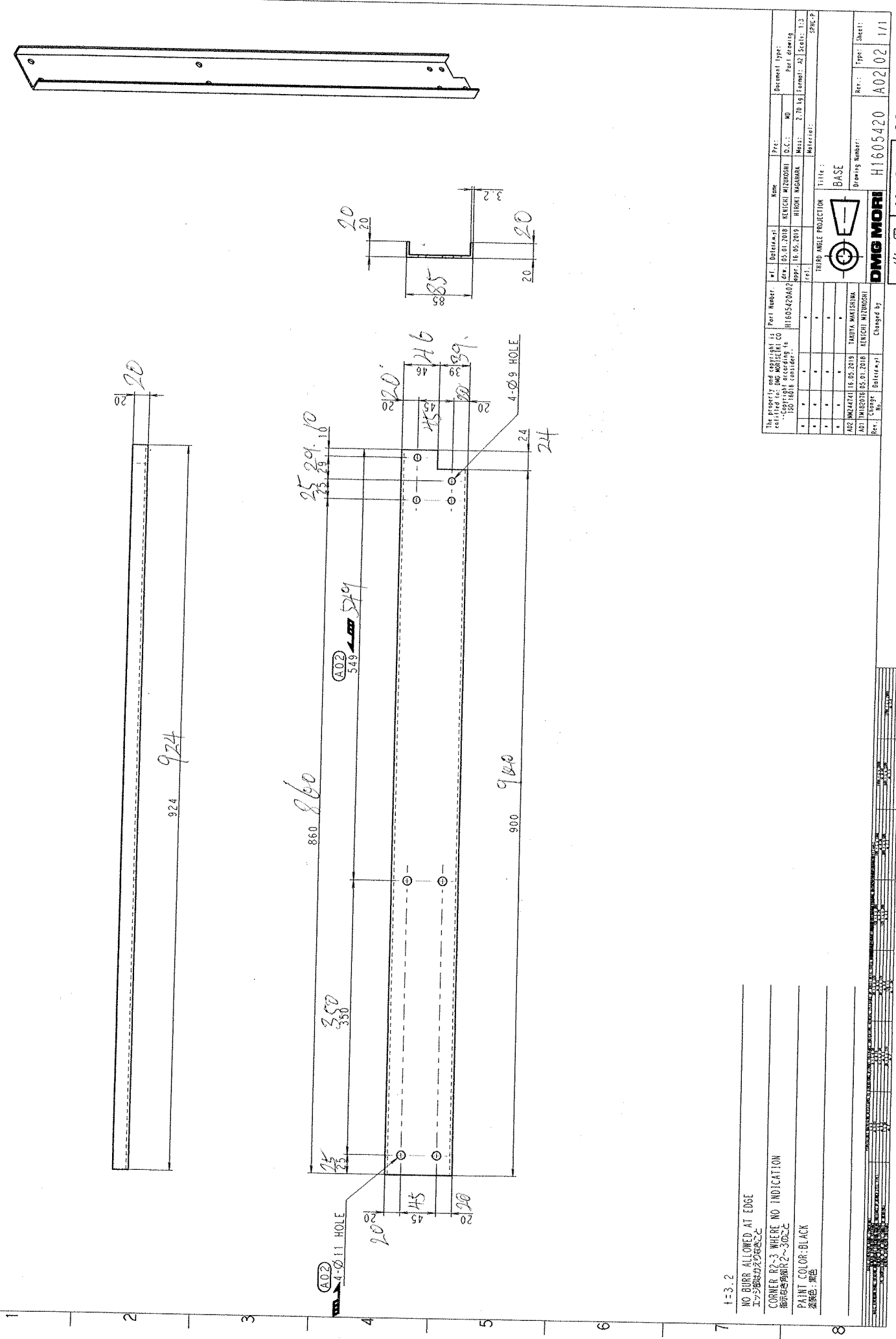

1=3.2  
 NO BURR ALLOWED AT EDGE  
 エッジ部バリを除去すること  
 CORNER R2-3 WHERE NO INDICATION  
 角部R2-3の箇所を指定しないこと  
 PAINT COLOR: BLACK  
 塗装色: 黒色

The property and application is certified as DMG MORI PART according to ISO 9001 certification.		Part Number:	Rev.:	Document type:
A01	1M182016 (S. O. 2018)	H1605420A0	01	Part drawing
A02	1M244741 (S. O. 2019)	H1605420A0	01	Part drawing
Drawn by: TADUYA MITSUHIKO		Checked by: KENICHI WATANOSE	Date: 22.05.01	
Title: BASE		Material: S45C		
Third Angle Projection		Scale: 1:3		
Drawing Number: H1605420		Sheet: 1/1		
Changed by: KENICHI WATANOSE		Date: 22.05.01		

出図 22.05.01 3217

A B C D E F G H

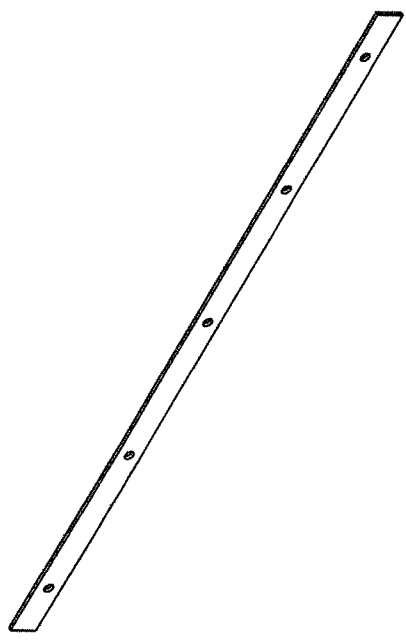

5-φ6 HOLE

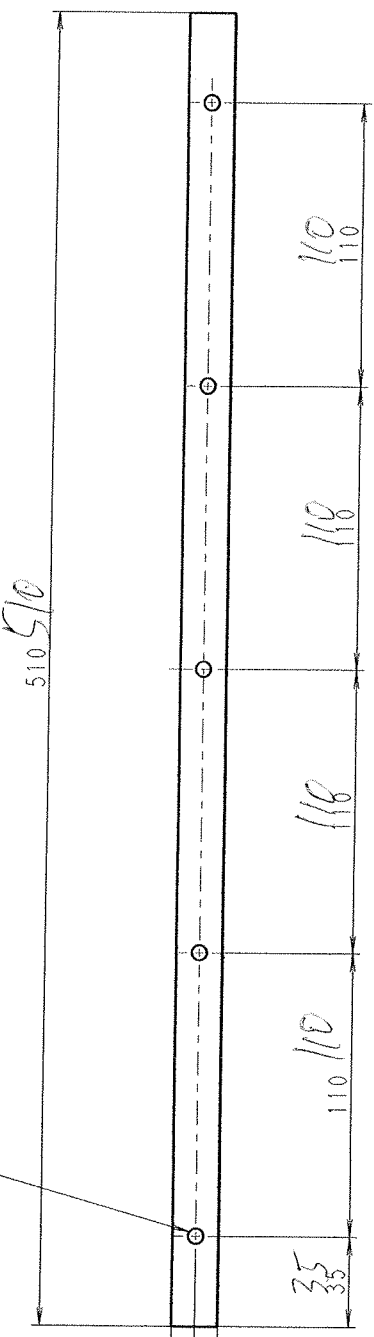

t=2.3

NO BURR ALLOWED AT EDGE  
エッジ部はかえりなきこと

CORNER R2~3 WHERE NO INDICATION  
指示なき角部R2~3のこと

PAINT COLOR: BLACK  
塗装色: 黒色

22.05.04

管理文書

The property and copyright is certified to: DMG MORI SEIJI CO		Part Number: H3201831A01		Date(d,m,y): 23.09.2019		Name: TOSHIYUKI BABA		Proc: O.C.: MD		Document type: Part drawing	
Copyright according to ISO 16016 considered		H3201831A01		23.09.2019		HIROKI NAGAHARA		Mess: 0.16 kg		Scale: 1:2	
								Material:		SPIC-P	
								THIRD ANGLE PROJECTION		Title: P/DMG3227-W001	
										Rev.: Type: Sheet: A01 HMG245445 23.09.2019 TOSHIYUKI BABA	
										Drawing Number: H3201831 A01 02 1/1	
										DMG MORI	

NO. OF WORK	1
DATE OF ORDER	2019.09.23
DATE OF DELIVERY	2019.10.11
DATE OF RECEIPT	2019.10.11
DATE OF INSPECTION	2019.10.11
DATE OF FINISH	2019.10.11
DATE OF SHIPMENT	2019.10.11
DATE OF DELIVERY	2019.10.11
DATE OF RECEIPT	2019.10.11
DATE OF INSPECTION	2019.10.11
DATE OF FINISH	2019.10.11
DATE OF SHIPMENT	2019.10.11
DATE OF DELIVERY	2019.10.11
DATE OF RECEIPT	2019.10.11
DATE OF INSPECTION	2019.10.11
DATE OF FINISH	2019.10.11
DATE OF SHIPMENT	2019.10.11

3227

WARNING: EXPORT CONTROLLED - RESTRICTED - CONFIDENTIAL  
Copyright © 2019 DMG MORI. All rights reserved. Violations are subject to sanctions incl. termination.  
Control Dept. for disclosure procedures and approvals. Violations are subject to sanctions incl. termination.

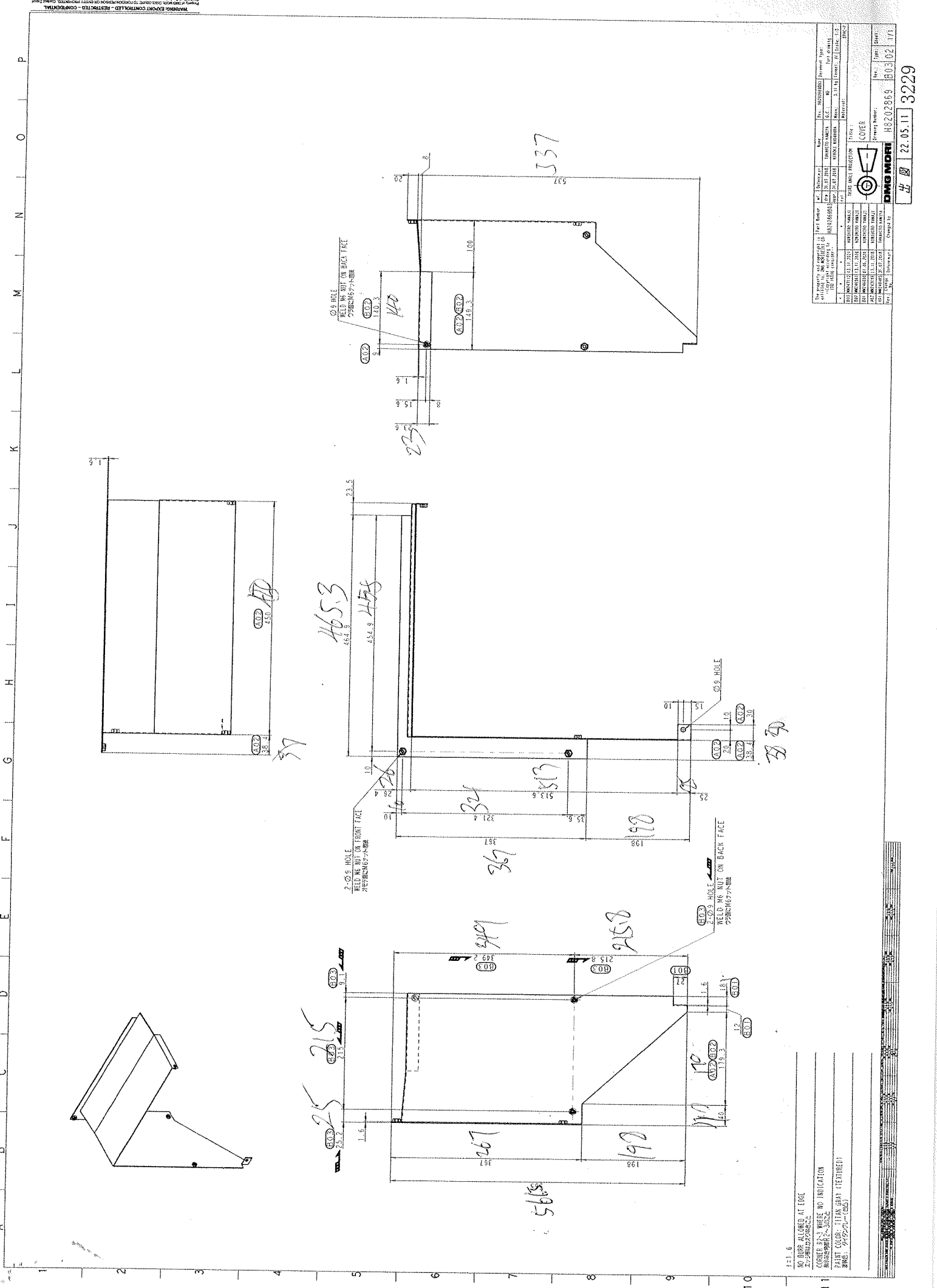

Fig. No.	188	Part Name	COVER	Rev.	1
Scale	1:1	Material	ALUMINUM	Drawn By	Y. MORI
Check By	M. MORI	Design No.	188-001	Project No.	3229
Drawn Date	22.05.11	Checked Date	22.05.11	Project Name	
Drawn By	Y. MORI	Checked By	M. MORI	Project No.	3229
Drawn Date	22.05.11	Checked Date	22.05.11	Project Name	

1:1.6  
 NO. HOLE ALIGNED AT EDGE  
 CORNER RAS WHERE NO INDICATION  
 PAINT COLOR: THKMS (TEITHREB)  
 納品色: 粉体黒 (G60)

565  
 369  
 324  
 319  
 198  
 215  
 213  
 465.3  
 464.3  
 458  
 377  
 379  
 370  
 537

Ø9 HOLE  
 WELD MG NUT ON FRONT FACE  
 2732R24677A-BER

Ø9 HOLE  
 WELD MG NUT ON BACK FACE  
 2732R24677A-BER

Ø9 HOLE  
 WELD MG NUT ON BACK FACE  
 2732R24677A-BER

22.05.11  
 Y. MORI  
 M. MORI

A B C D E F G H I J K

1 2 3 4 5 6 7 8

WARNING: EXPORT CONTROLLED - RESTRICTED - CONFIDENTIAL  
 Property of DMG MORI. Disclosure to foreign person or entity prohibited. Contact Export Control Dept. for additional procedures and approvals. Violators are subject to law enforcement investigation.

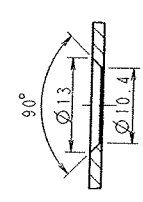
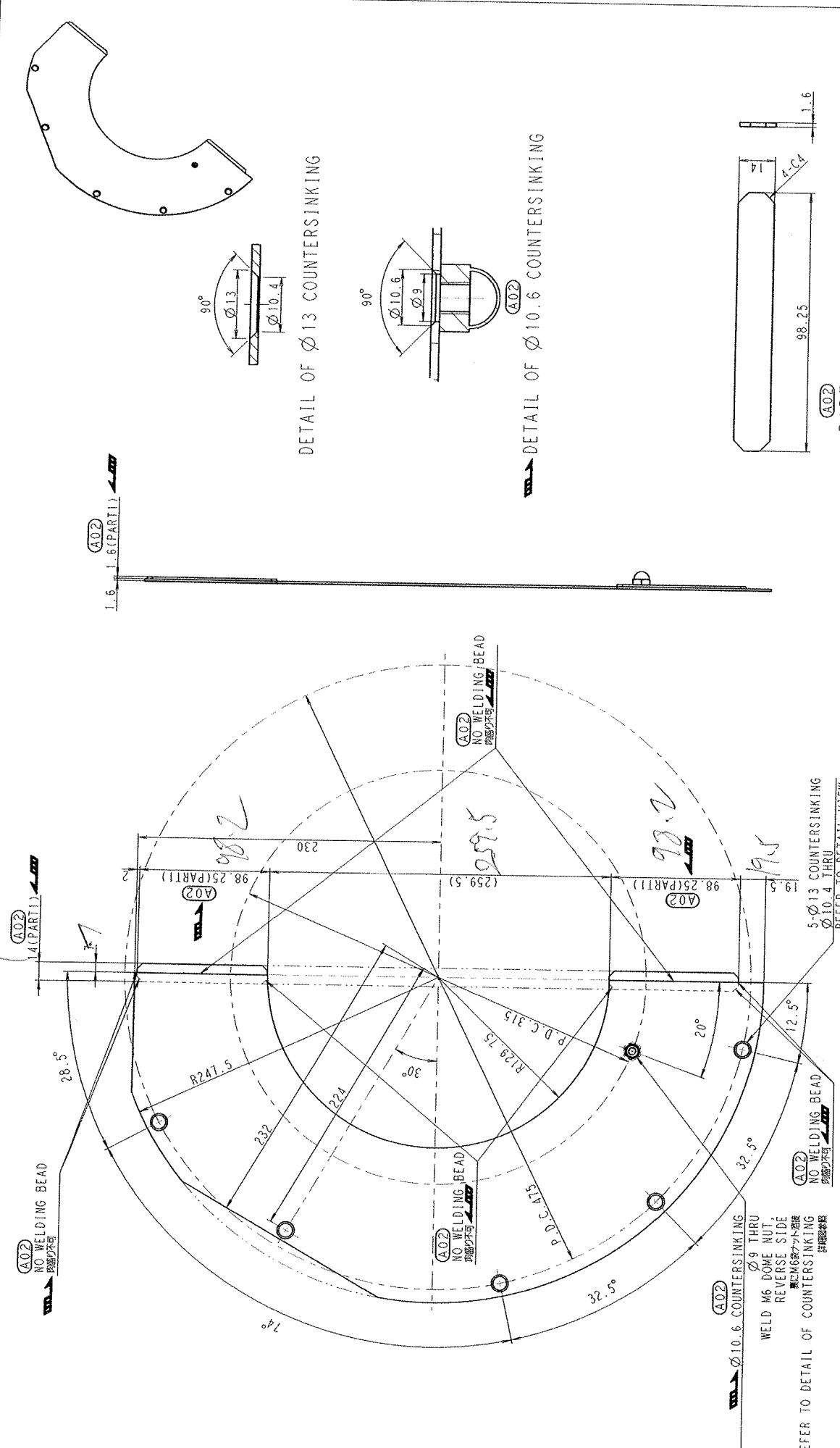

DETAIL OF Ø13 COUNTERSINKING

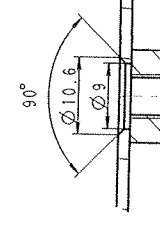

DETAIL OF Ø10.6 COUNTERSINKING

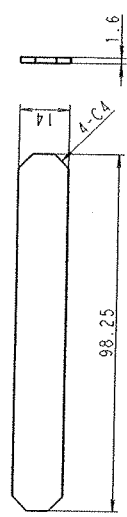

PART1(+1.6, S=1:1, 2PIECES)

Part Number	Part Name	Proc. No.	Doc. No.	Doc. Type
H3201811A02	LID	MD	H3201811A02	Part drawing
Appr. 16.10.2018	ISO 9001	Appr. 0.81 kg	Temp. A2	1:2
Material	THIRD ANGLE PROJECTION	Title :		
		LID		
Rev. No.	Design	Checked by	Drawing Number	
A02	MD245509	E. O. 2015	H3201811 A02 02 1/1	
			Rev. Type: Sheet	
			Changed by	
			DMG MORI	

DATE: 22.05.04  
 3237

NO BURR ALLOWED AT EDGE  
 エッジ面バリがみだりなきこと  
 CORNER R2-3 WHERE NO INDICATION  
 角面半径R2-3の箇所は指定なし  
 PAINT COLOR: CALCIUM WHITE (SMOOTH)  
 塗料色: カルシウムホワイト(平滑)

5-Ø13 COUNTERSINKING  
 Ø10.4 THRU  
 REFER TO DETAIL VIEW  
 (FROM OBLVERSE SIDE)  
 詳細図参照のこと  
 (オブリバース側より)

Ø10.6 COUNTERSINKING  
 Ø9 THRU  
 WELD M6 DOME NUT  
 REVERSE SIDE  
 逆面M6ドームナット溶接  
 REFER TO DETAIL OF COUNTERSINKING  
 詳細図参照

NO WELDING BEAD  
 溶接跡なし

NO WELDING BEAD  
 溶接跡なし

NO WELDING BEAD  
 溶接跡なし

Ø13 COUNTERSINKING  
 Ø10.4 THRU  
 詳細図参照のこと  
 (FROM OBLVERSE SIDE)  
 (オモテ面より)  
 WELD M6 CAP NUT  
 ALL AROUND ON BACK FACE  
 フラ面にM6キャップナット取付

3-Ø10.6 COUNTERSINKING  
 Ø9 THRU  
 詳細図参照のこと  
 (FROM OBLVERSE SIDE)  
 (オモテ面より)  
 WELD M6 NUT,  
 ON BACK FACE  
 フラ面にM6ナット取付

NO BURR ALLOWED AT EDGE  
 エッジ面からバリを除去すること  
 CORNER R2-3 WHERE NO INDICATION  
 角部半径R2-3の箇所  
 PAINT COLOR: CALCIUM WHITE (SMOOTH)  
 塗料色: カルシウムホワイト(平滑)

4-Ø13 COUNTERSINKING  
 Ø10.4 THRU  
 詳細図参照のこと  
 (FROM OBLVERSE SIDE)  
 (オモテ面より)

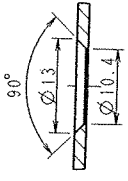
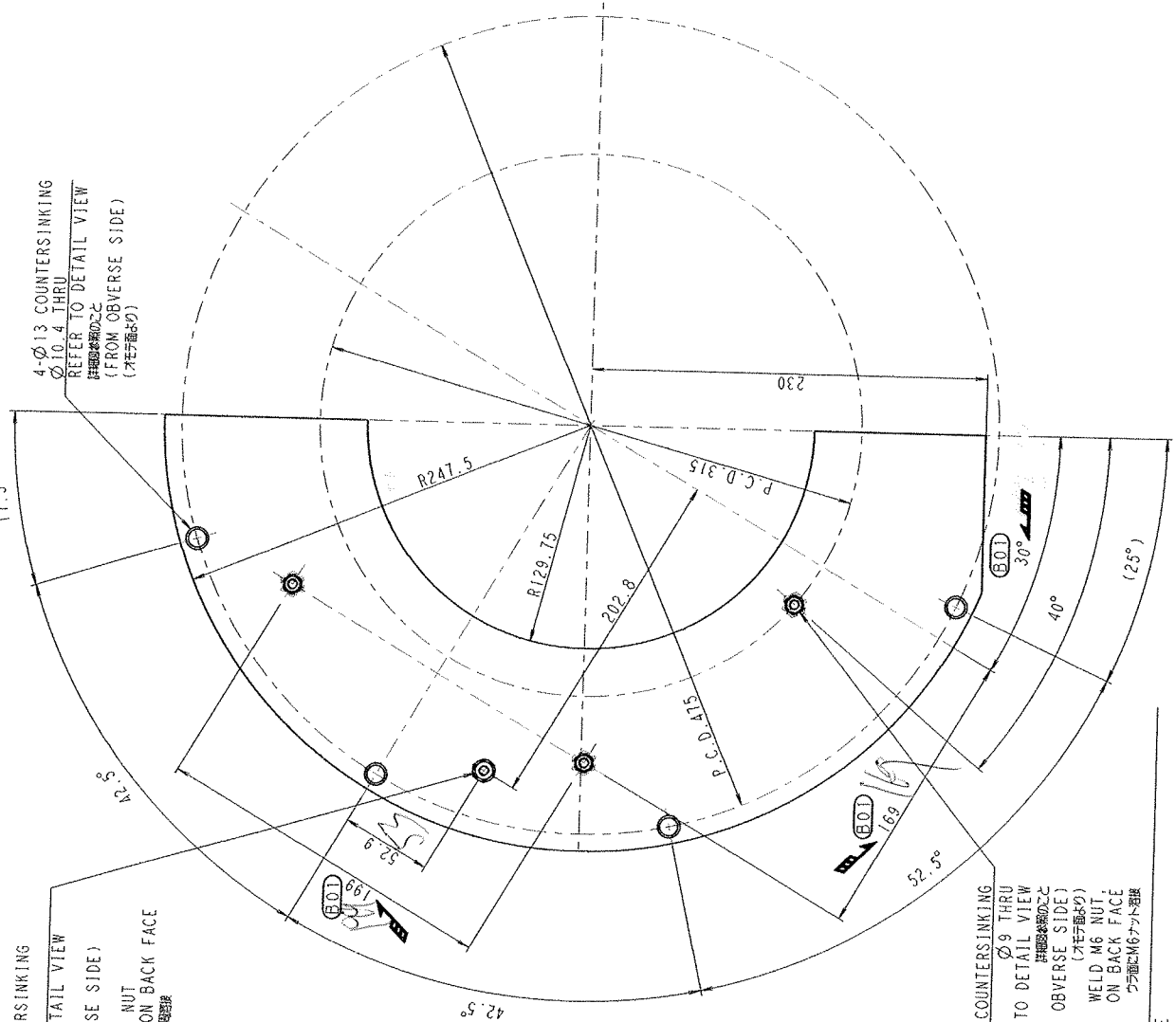

DETAIL OF Ø13 COUNTERSINKING

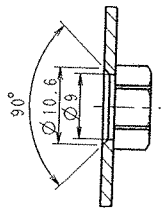

DETAIL OF Ø10.6 COUNTERSINKING

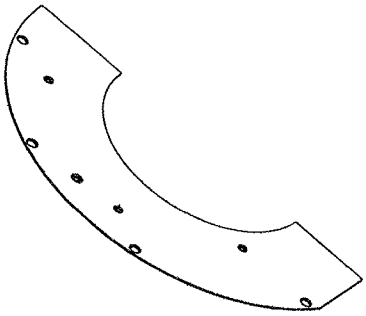

(1.6)

The property and copyright in this drawing are the property of DMG MORI SEIKI CO., LTD. All rights reserved. This drawing is to be used only for the purpose specified.		Part Number H3201812001	Shipment Date: 23.04.2020	Name TAMARITO MAMTA	Doc. No. MD	Doc. Name Part drawing
Material SPBC-P	Weight 0.88 kg	Drawing Number H3201812	Scale 1:1	Revision 1/1	Title L1D	
Classification CLASSIFIED BY: H3201812001	Classification CLASSIFIED BY: H3201812001	Classification CLASSIFIED BY: H3201812001	Classification CLASSIFIED BY: H3201812001	Classification CLASSIFIED BY: H3201812001	Classification CLASSIFIED BY: H3201812001	Classification CLASSIFIED BY: H3201812001

DATE	DESCRIPTION
2020.04.23	INITIALS
2020.04.23	INITIALS
2020.04.23	INITIALS
2020.04.23	INITIALS
2020.04.23	INITIALS
2020.04.23	INITIALS
2020.04.23	INITIALS
2020.04.23	INITIALS
2020.04.23	INITIALS

出 22.05.04 3238

WARNING: EXPORT CONTROLLED - RESTRICTED - CONFIDENTIAL  
 Control Data, for distribution procedures and approval. Violation may subject to sanctions and penalties.